

OPERATION MANUAL

OSCILLOSCOPE

MODEL COS6150

KIKUSUI ELECTRONICS CORPORATION

85 3. 58

843747A

TABLE OF CONTENTS

	PAGE
1. GENERAL	1
1.1 Description	1
1.2 Features	1
2. SPECIFICATIONS	5
3. PRECAUTIONS BEFORE OPERATING THE OSCILLOSCOPE	14
3.1 Unpacking the Oscilloscope	14
3.2 Checking the Line Voltage	14
3.3 Environments	15
3.4 CRT Intensity	15
3.5 Withstanding Voltages of Input Terminal	15
4. OPERATION METHOD	16
4.1 Explanation of Front Panel	16
4.2 Explanation of Rear Panel	28
4.3 Basic Operation	32
4.4 Vertical Mode Switches	35
4.5 CH3 HOR Operation	38
4.6 Triggering	39
4.7 Single-sweep Operation	47
4.8 Sweep Magnification	48
4.9 Waveform Magnification with Delayed Sweep	49
4.10 Delayed ALT Sweep	51
4.11 B ENDS A Mode	52
5. MEASURING METHODS	54
5.1 Connection Method of Input Signal	54
5.2 Voltage Measurement	57
5.3 Current Measurement	57
5.4 Time Measurement	58
5.5 Frequency Measurement	58
5.6 Measurement of Phase Difference	60
5.7 Characteristics of Pulse Waveform	61
5.8 10:1 Probe Compensation	64
* BLOCK DIAGRAM	

843748

1. GENERAL

1.1 Description

Kikusui Model COS6150 Oscilloscope is a universal-type portable oscilloscope which is capable of 5-channel 12-trace display. It employs a 6-inch rectangular type cathode-ray tube with red internal graticule.

The COS6150 oscilloscope is sturdy, easy to operate, and extremely reliable. This scope has many convenient features and special functions which make it an ideal instrument for diversified types of research and development of electronic equipment. It can also be efficiently used in production line maintenance and service applications.

1.2 Features

The features of the COS6150 Oscilloscope can be summarized as follows:

(1) Ease of use:

Light torque lever switches and pushbutton switches are used. These and other controls are laid out in the most convenient locations making the oscilloscope extremely easy to operate.

(2) Clear waveform observation:

The cathode-ray tube is a 6-inch large-screen rectangular type CRT with a red internal graticule of 80 mm × 100 mm (3.15 in. × 3.94 in.) The red graticule produces a high resolution background for easy waveform viewing.

(3) High acceleration voltage (20 kV):

The high acceleration voltage of the CRT ensures a bright trace for observation and photography.

(4) High sensitivity and wide frequency bandwidth:

The maximum vertical sensitivity is 1 mV/DIV (with $\times 5$ MAG) and the frequency response is 150 MHz or greater (-3 dB).

(5) High input impedance:

The input impedance of CH1, CH2, CH3, CH4 and CH5 (EXT TRIG) is $1\text{ M}\Omega \pm 1\%$, $20\text{ pF} \pm 2\text{ pF}$, allowing the use of $10\times$ Probes.

(6) 5-channel simultaneous display:

The COS6150 employs a new type of vertical mode switching circuit which enables display of any combination of CH1, ADD (CH1 \pm CH2), CH2, CH3, and TRIG VIEW (CH4 and CH5). Up to five channels can be displayed simultaneously; up to twelve traces can be displayed when in the alternate sweep mode.

(7) Trigger level lock:

A new trigger level lock circuit eliminates the requirement of triggering adjustments on most signals. (Manual control is still available for triggering on complex waveforms.)

(8) Stable alternate triggering function:

When in the alternate triggering mode, stable triggering can be attained even when the signals of CH1, CH2 and CH3 are not time related. (patent pending)

(9) TV sync triggering:

The COS6150 has a sync separator circuit, which allows triggering for TV V signal and TV H signal. It is automatically switched with the TIME/DIV control.

(10) B END'S A switch separated from holdoff control knob:

The B END'S A switch is installed separately from the holdoff control switch. Holdoff control can be used while in the B END'S A mode.

(11) Maximum sweep time 2 nsec/DIV with $\times 10$ MAG function:

With the $\times 10$ MAG function, the highest sweep speed of 20 nsec/DIV can be multiplied by a factor of 10 to attain a maximum sweep speed of 2 nsec/DIV.

(12) Alternate sweep:

The A sweep and the delayed sweep can be viewed simultaneously in the alternate mode.

(13) Linear focus:

Once the beam focus is adjusted, it is automatically maintained in this state regardless of changes in intensity.

(14) Multiple-channel X-Y operation:

By using the CH3 HOR channel as the X-axis input and all other channels as the Y-axis inputs, up to four channels of X-Y operation can be viewed.

2. SPECIFICATIONS

Vertical axes

Item	Specification	Remarks
CH1 and CH2 Sensitivity	5 mV/DIV - 10 V/DIV 1 mV/DIV - 2 V/DIV (when $\times 5$ MAG)	1-2-5 sequence, 11 ranges
Sensitivity accuracy	$\pm 2\%$ $\pm 4\%$ (when $\times 5$ MAG)	10 to 35°C (50 to 95°F), at 4,5 DIV
Variable vertical sensitivity	To 1/2.5 or less of panel-indicated value	
Frequency bandwidth	DC - 150 MHz (-3 dB) DC - 10 MHz (-3 dB), when $\times 5$ MAG AC coupling: Low limit frequency 10 Hz	With reference to 50 kHz, 8 DIV. Except when in bandwidth limit mode (5 mV/DIV 10 - 30°C (50 - 86°F))
Input coupling	AC, DC, GND	
Input impedance	1 M Ω $\pm 1\%$, 20 pF ± 2 pF	
Allowable input voltage	400 V (DC + AC peak)	Frequency 1 kHz or lower
Square wave characteristics	Overshoot: Not greater than 3% (at 20 mV/DIV range) Other distortions: Not greater than 2%	Other ranges: Add 5% VARIABLE knob is CAL'D position. (5 mV/DIV 10 - 30°C (50 - 86°F))
CH3 (HOR) Sensitivity	0.1 V, 0.5 V/DIV	
Sensitivity accuracy	$\pm 3\%$	10 to 35°C (50 to 95°F)

84.12.17 843753B

Item	Specification	Remarks
Frequency bandwidth	DC - 150 MHz (-3 dB) AC coupling: Low limit frequency 10 Hz	With reference to 50 kHz, 8 DIV
Input coupling	AC, DC, GND	
Input impedance	1 M Ω \pm 1%, 20pF \pm 2 pF	
Allowable input voltage	400 V (DC + AC peak)	Frequency 1 kHz or lower
Square wave characteristics	Overshoot: Not greater than 8% Other distortions: Not greater than 3%	
CH4 and CH5	CH4: A TRIG EXT input CH5: B TRIG EXT input	
Sensitivity	0.1 V, 0.5 V/DIV	
Sensitivity accuracy	\pm 3%	10 - 35°C (50 - 95°F)
Frequency bandwidth	DC - 100 MHz (-3 dB) AC coupling: Low limit frequency 10 Hz	With reference to 50 kHz, 4 DIV
Input coupling	CH4: AC, HF REJ, TV, DC CH5: AC, HF REJ, LF REJ, DC	Selectable with the coupling switch
Input impedance	1 M Ω \pm 1%, 20 pF \pm 2 pF	
Allowable input voltage	100 V (DC + AC peak)	Frequency 1 kHz or lower
Square wave characteristics	Overshoot: Not greater than 10% Other distortions: Not greater than 5%	
Rise time	Approx. 2.3 nsec (Approx. 35 nsec when \times 5 MAG)	CH1, CH2, CH3, 6DIV CH4, CH5, Approx. 3.5 ns 4DIV

88, 3, 28
843754A

Item	Specification	Remarks
Signal delay time	Approx. 30 nsec (with delay cable of approx. 90 nsec)	The displayed portion preceding the triggering point
Delay time differences among channels	Not greater than ± 0.5 nsec among CH1, CH2, and CH3	
Polarity change	CH2 only	
DC balance shift	± 0.5 DIV (± 2.0 DIV when in $\times 5$ MAG)	CH1 and CH2, at 10 mV/DIV
Display modes	Simultaneous displays of CH1, ADD (CH1 + CH2), CH2, CH3, and TRIG VIEW (CH4 and CH5) are possible in any combination. Single X-Y (CH1 for X-axis and CH2 for Y-axis) also is possible.	
Chopping repetition frequency	1 MHz/ (number of displayed channels) $\pm 40\%$	
Common mode rejection ratio	50:1 or better at 50 kHz, sinusoidal wave	When sensitivities of CH1 and CH2 are set equal
Isolation between channels	At least 1000:1 at 50 kHz At least 30:1 at 100 MHz	At 5 mV/DIV range
Bandwidth limit	With filter for approx. 3 dB attenuation at 20 MHz	
Linearity	± 0.1 DIV or less of amplitude change when waveform of 2 DIV at graticule center is moved vertically.	
CH1 signal output Output voltage	Approx. 10 mV per 1 DIV deflection amplitude on screen	50-ohm termination
Frequency bandwidth	DC - 100 MHz (-6 dB)	
Output resistance	Approx. 50 ohms	

85. 3. 28 843755A

Triggering

Item	Specification	Remarks
Internal trigger selection (INT TRIG switch)	CH1, CH2, CH3, ALT (When in ALT mode, a trigger source is selected depending on the vertical operation mode.)	When in ADD, the CH1 input signal is used as the trigger source signal.
A trigger		
Signal source	INT, LINE, EXT, EXT÷5	
Coupling	AC, HF REJ, TV, DC	
Polarity	+ or -	
Sensitivity	DC - 20 MHz: 0.4 DIV (0.04 V) 20 - 150 MHz: 1.5 DIV (0.15 V) Video signal: 1.0 DIV (0.1 V) AC coupling: Attenuates signal components of lower than 10 Hz. HF REJ: Attenuates signal components of higher than 50 kHz.	The values enclosed in the parentheses are the input sensitivities when in the EXT trigger mode.
B trigger		
Signal source	INT, EXT, EXT÷5	
Coupling	AC, HF REJ, LF REJ, DC	
Polarity	+ or -	
Sensitivity	DC - 20 MHz: 0.4 DIV (0.04 V) 20 - 150 MHz: 1.5 DIV (0.15 V)	The values enclosed in the parentheses are the input sensitivities when in the EXT trigger mode.

Item	Specification	Remarks
EXT trigger input	CH4 and CH5 input terminals used in common	
Input impedance	1 M Ω \pm 2%, 20 pF \pm 2 pF	
Maximum allowable input voltage	100 V (DC + AC peak)	Frequency 1 kHz or lower
AUTO mode	Satisfies the A trigger sensitivity specification for signal repetition frequency of 50 Hz or over.	
LEVEL LOCK	Satisfies the value of the above trigger sensitivity plus 0.5 DIV (0.05 V) for signal of duty cycle 20:80 and repetition frequency 50 Hz - 100 MHz.	

Horizontal axis

Item	Specification	Remarks
Horizontal axis display	A, A INT, ALT, B (DLY'D)	
A sweep		
Sweep mode	AUTO, NORM, SINGLE	
Sweep time	20 nsec/DIV - 0.5 sec/DIV 2 nsec/DIV - 50 msec/DIV (when in "x 10 MAG")	1-2-5 sequence, 23 ranges
Sweep time accuracy	\pm 2%	10 to 30°C (50 to 95°F)
Variable sweep time	To 1/2.5 or slower of panel-indicated value	
Holdoff time	Continuously variable to 2 times or over of sweep length (time) at 20 nsec/DIV - 0.1 sec/DIV ranges	

Item	Specification	Remarks
B sweep		
Delay system	Continuous delay or triggered delay	
Sweep time	20 nsec/DIV - 0.5 sec/DIV 2 nsec/DIV - 50 msec/DIV (when in "×10 MAG")	1-2-5 sequence, 23 ranges
Sweep time accuracy	±2%	10 to 35°C (50 to 95°F)
Delay time	0.2 μsec - 5 sec	
Delay time accuracy	±2% of multial-indicated value (except 0 - 0.50) ±3% of value-read on screen	
Delay jitter	1/20,000 or less $\frac{\text{B sweep time}}{\text{A sweep time}} \times \frac{\text{jitter width}}{10 \text{ DIV}}$	Jitter width 0.5 DIV or less at A: 1 msec/DIV B: 1 μsec/DIV
Sweep magnification	10 times (maximum sweep time 2 nsec/DIV)	Both A and B
Magnified sweep time accuracy	0.1 μsec/DIV - 0.5 sec/DIV ranges: ±4% 20 nsec/DIV - 50 nsec/DIV ranges: ±5%	10 to 35°C (50 to 95°F)
Linearity	±3% ±5% (when in "×10 MAG")	
CH3 sweep (CH3 HOR)	CH3 input signal is used as sweep trigger signal. For vertical axes, any combination of CH1, ADD (CH1 + CH2), CH2, and TRIG VIEW can be simultaneously displayed in CHOP mode.	
Sensitivity	0.1 V, 0.5 V/DIV	Same as CH3
Sensitivity accuracy	±3%	Same as CH3

Item	Specification	Remarks
Frequency bandwidth	DC - 5 MHz (-3 dB) AC coupling: Low limit frequency 10 Hz	With reference to 50 kHz, 10 DIV
Phase difference between vertical axes	Not greater than 3° at DC - 100 kHz	
X-Y mode	X-axis: CH1 input signal Y-axis: CH2 input signal	
Sensitivity	5 mV - 10 V/DIV	Same as CH1
Sensitivity accuracy	±3% ±5% (when in "×5 MAG")	10 to 35°C (50 to 95°F)
Frequency bandwidth	DC - 5 MHz (-3 dB) AC coupling: Low limit frequency 10 Hz	With reference to 50 kHz, 10 DIV
X-Y phase difference	Not greater than 3° at DC - 100 kHz	
Sweep signal output	A sweep signal	
Output voltage	Approx. 5 Vp-p	Zo ≅ 10 kΩ
Sweep gate output	A sweep gate signal	
Output voltage	Approx. 1 Vp-p	Zo ≅ 100 Ω

Z axis

Item	Specification	Remarks
Sensitivity	3 Vp-p (Trace becomes brighter with negative input.)	
Frequency bandwidth	DC - 10 MHz	
Input resistance	5 kΩ ±10%	
Allowable input voltage	50 V (DC + AC peak)	AC: 1 kHz or lower

85. 3. 28
843759A

Calibration voltage

Item	Specification	Remarks
Waveform	Positive-going square wave	
Frequency	1 kHz \pm 5%	
Duty ratio	Within 45:55	
Output voltage	2 V, 200 mV \pm 2%	
Rise time	Approx. 1 μ sec	
Output resistance	2 V: Approx. 2 k Ω 200 mV: Approx. 200 Ω	

CRT

Item	Specification	Remarks
Type	6-inch rectangular type, internal graticule	
Fluorescent screen	P31 phosphor	
Acceleration voltage	Approx. 20 kV	
Effective screen size	8 \times 10 DIV	1 DIV = 10 mm (0.39 in.)
Graticule	Internal graticule, continuously adjustable illumination	Red

Mechanical specifications

Item	Specification	Remarks
Dimensions of mainframe	310 W \times 150 H \times 400 D mm (12.20 W \times 5.91 H \times 15.75 D in.)	
Maximum dimensions	370 W \times 200 H \times 475 D mm (14.57 W \times 7.87 H \times 18.70 D in.)	
Weight	Approx. 9.5 kg (21 lbs)	

843760

o Line power requirements

Voltage: 100 V, 115 V, 215 V, 230 V; with 10% allowance.
Selectable by connector change

Frequency: 50 Hz or 60 Hz

Wattage: Approx. 58 W (Approx. 70 VA)

o Operating environment

To satisfy specifications: 5 to 35°C (41 to 95°F),
85% RH

Maximum operating ranges: 0 to 40°C (32 to 104°F),
90% RH

o Accessories

P150-2 probes (10:1, 1.5 m).....	(89-03-0340)	2
942A terminal adaptors	(W4-986-011)	3
Slow blow fuse (0.5A)	(99-02-0001)	1
Slow blow fuse (1 A)	(99-02-0002)	1
Power cord	(85-10-0120)	1
Instruction manual	()	1

Power cord (USA and Canada) (85-10-0170)
(European countries) ..(85-10-0140)

85, 3, 28

843761C

3. PRECAUTIONS BEFORE OPERATING THE OSCILLOSCOPE

3.1 Unpacking the Oscilloscope

The oscilloscope is shipped from the factory fully inspected and tested. Upon receipt of the instrument, please unpack and inspect it for any damage which might have been sustained during transportation. If any sign of damage is found, please notify the bearer and/or the dealer.

3.2 Checking the Line Voltage

The oscilloscope can operate on any one of the line voltages shown in the below table. Insert the line voltage selector plug in the corresponding position on the rear panel. Before connecting the power plug to an AC line outlet, be sure to check that the voltage selector plug is set in the position corresponding to the correct line voltage. Note that the oscilloscope may not operate properly or may be damaged if it is connected to a wrong voltage AC line.

When line voltages are changed, replace fuses as required.

Selector plug position	Nominal voltage	Voltage tolerance	Fuse
A	100 V	90 - 110 V	1 A, slow blow
B	115 V	104 - 126 V	
C	215 V	194 - 236 V	0.5 A, slow blow
D	230 V	207 - 253 V	

3.3 Environments

The normal ambient temperature range of this instrument is 0 to 40°C (32 to 104°F). Operation of the instrument outside of this temperature range may cause damage to the circuits.

Do not use the instrument in a place where a strong magnetic or electric field exists. Such fields may disturb the measurement.

3.4 CRT Intensity

In order to prevent permanent damage to the CRT, do not make the CRT trace excessively bright or leave the spot stationary for an unreasonably long time.

3.5 Maximum Voltages of Input Terminals

The maximum voltages of the instrument input terminals and probe input terminals are as shown in the following table. Do not apply voltages higher than these limits.

Input terminal	Maximum allowable input voltage
CH1, CH2, CH3 inputs	400 V (DC + AC peak)
EXT TRIG (CH4, CH5) input	100 V (DC + AC peak)
Probe input	600 V (DC + AC peak)
Z AXIS input	50 V (DC + AC peak)

Note: AC Frequency is 1 kHz or below.

843703

4. OPERATION METHOD

4.1 Explanation of Front Panel (See Figure 4-1.)

o CRT circuits:

POWER	①	Main power switch of the instrument. When this switch is turned on, the LED ② above the switch is also turned on.
INTEN	⑦	Controls the brightness of the spot or trace.
(PUSH BEAM FIND)		Even when the beam is outside of the screen, it can be located by pressing this beam finder button.
B INTEN	⑥	Potentiometer for adjusting trace intensity when in B sweep mode.
FOCUS	⑤	Focusing the trace to the sharpest image.
ILLUM	③	Graticule illumination adjustment.
TRACE ROTATION	④	Potentiometer for aligning the horizontal trace in parallel with graticule lines.
Bezel	②⑦	For installing a camera mount
Filter	②⑧	Blue filter for ease of waveform observation. Can be removed.

o Vertical axis:

CH1 (X) input (21) Vertical input terminal of CH1.
When in X-Y operation, X-axis
input terminal.

CH2 (Y) input (14) Vertical input terminal of CH2.
When in X-Y operation, Y-axis
input terminal.

CH3 (HOR) input (12) Vertical input terminal for CH3.
When TIME/DIV switch (39) is set
in the **CH3 HOR** position, this
terminal becomes the horizontal
axis input terminal.

AC-GND-DC (13) (20) Switch for selecting connection
mode between input signal and
vertical amplifier.



AC: AC coupling
GND: Vertical amplifier input is
grounded and input terminals
are disconnected.

DC: DC coupling

..... (9) (10) (11) Select input coupling and sensitivity
of CH3.

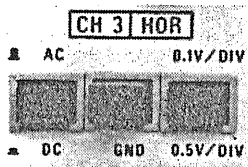

AC/DC: Selects coupling of input
signal to CH3 amplifier
between AC coupling and
DC coupling.

GND: Grounds CH3 amplifier input
signal and opens the input
terminal.

843765

0.1 V/0.5 V: Selects CH3 amplifier sensitivity between 0.1 V/DIV and 0.5 V/DIV.

VOLTS/DIV (16) (23) Select the vertical axis sensitivity, from 5 mV/DIV to 10 V/DIV with 11 ranges.

VARIABLE (15) (22) Fine adjustment of sensitivity, with a factor of 1/2, 5 or over of panel-indicated value. When in the CAL'D position, sensitivity is calibrated to panel-indicated value. When not in the CAL'D position, the UNCAL lamp (18) or (25) turns on.

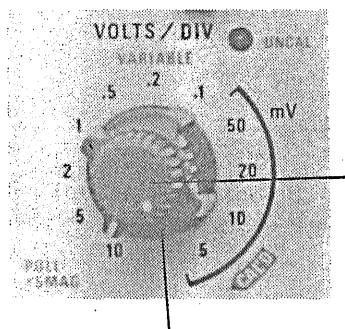

(16) (23)

When this knob is pulled out, the amplifier sensitivity is multiplied by 5 times.

POSITION (17) (24) Vertical positioning control of trace or spot.

When in X-Y operation, knob (24) is for horizontal positioning.

VERT MODE (26) Select vertical axis operation modes and frequency bandwidth limit function. Any combination of CH1, ADD (CH1 + CH2), CH2, CH3 and TRIG VIEW can be simultaneously displayed. The functions of the buttons as they are depressed are as follows:

CH1: CH1 signal is displayed.

ADD: Sum signal (CH1 + CH2) is displayed.

85.4.22 843766 B

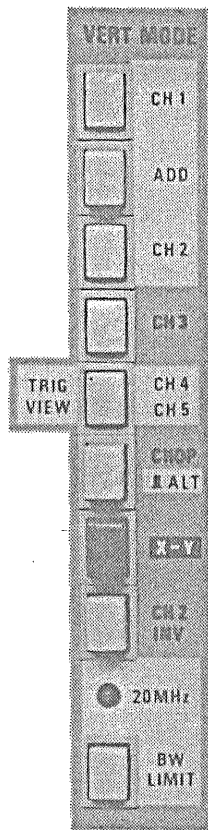

CH2: CH2 signal is displayed.

CH3: CH3 signal is displayed.

TRIG VIEW By depressing the TRIG (CH4, CH5): VIEW button it is possible to look at either A TRIG VIEW (CH4) or B TRIG VIEW (CH5). Both TRIG VIEW A and TRIG VIEW B can be viewed at the same time if the B TRIG SOURCE switch is set in the INT or EXT ($\div 5$) position.

CHOP Selects switching mode when

\square ALT: in multichannel operation.

\square : Alternate mode

\square : Chopping mode

X-Y: Oscilloscope operates as an X-Y scope, with CH1 for X-axis and CH2 for Y-axis. This button has the highest priority over all other buttons.

CH2 INT: Polarity of CH2 signal is inverted.

The up state is for normal polarity and the depressed state is for inverted polarity.

BW LIMIT: Limits the bandwidth of the vertical amplifier to approximately 20 MHz, cutting off the frequency components higher than this limit.

85. 3. 28
842767A

o Triggering

INT TRIG (19)



Selects the internal trigger signal source. The signal selected by this switch is fed to the A trigger circuit if SOURCE switch (35) is set in the INT state or to the B trigger circuit if SOURCE switch (48) on rear panel is set in the INT state.

CH1: Input signal of CH1 is used as trigger signal.

CH2: Input signal of CH2 is used as trigger signal.

CH3: Input signal of CH3 is used as trigger signal.

ALT: Asynchronous signals on CH1, CH2 and CH3 may be viewed simultaneously using the INT TRIG ALT mode. (For details, see Subsection 4.6.)

External trigger (CH4).. (36)
Input terminal



This terminal is used for both the CH4 input signal and the external trigger signal for the A trigger circuit. For the external trigger operation, set the SOURCE switch (33) in the EXT or the EXT ÷ 5 position.

843768

External trigger (CH5) ..
Input terminal

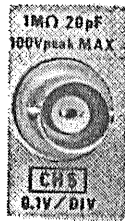

④⑥ This terminal is used for both the CH5 input signal and the external trigger signal for the B trigger circuit. For the external trigger operation, set the SOURCE switch ④⑧ in the EXT or the EXT ÷ 5 position.

SOURCE



③⑤ This switch is used to select the trigger signal source for the A trigger circuit. The signal selected by this switch is used directly as the input signal of the TRIG VIEW (CH4).

INT: Internal signal selected by INT TRIG switch ①⑨ is used as trigger signal.

LINE: AC line signal is used as trigger signal.

EXT: Input signal of external trigger (CH4) input terminal ③⑥ is used as trigger signal.

EXT ÷ 5: Input signal of external trigger (CH4) input terminal ③⑥ is attenuated to 1/5 and used as trigger signal.

SOURCE



④⑧ Selects between continuous delay and triggered delay; selects the trigger signal source for the B trigger circuit.

START AFTER DELAY:

Selects the continuous delay mode independent of the B trigger signal.

843769

The B sweep starts immediately after the period determined by DELAY TIME switch (39) and DELAY TIME MULTI switch (47) has elapsed.

If this switch is set in any other position, the B sweep operates in the triggered delay mode, and it starts when the sweep delay time has elapsed after the B trigger signal has been applied.

INT: Internal trigger signal selected by INT TRIG switch (19) is used as trigger signal.

EXT: Input signal of external trigger (CH5) input terminal (46) is used as trigger signal.

EXT + 5: Input signal of external trigger (CH5) input terminal (46) is attenuated to 1/5 and used as trigger signal.

COUPLING (34) (49) Select coupling modes between trigger signal sources and trigger circuits;

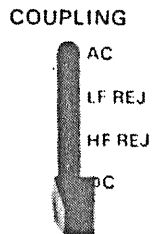

AC: AC coupling

LF REJ: AC coupling, with components lower than 50 Hz rejected.

HF REJ: AC coupling, with components higher than 50 Hz rejected.

85.3.28
843770A

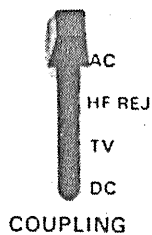

DC: DC coupling

TV: The sweep circuit is connected to the TV sync separator circuit and the sweeps are triggered with TV V or TV H signal at a rate selected by the A TIME/DIV switch (39)

TV V: 0.5 sec/DIV - 0.1 msec/DIV

TV H: 50 usec/DIV - 20 nsec/DIV.

SLOPE (33) (50)

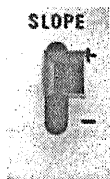

Selects the triggering slope.

"+": Triggering occurs when the trigger signal crosses the trigger level in positive-going direction.

"-": Triggering occurs when the trigger signal crosses the trigger level in negative-going direction.

HOLDOFF (31)

LEVEL (32)

These double-knob controls are for holdoff time adjustment and trigger level adjustment. The pulled out position of the LEVEL knob is for the B END'S A mode.

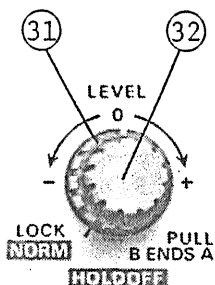

The HOLDOFF time control is used when the signal waveform is complex and stable triggering cannot be attained with LEVEL knob (32) alone.

The LEVEL knob is for displaying a synchronized stationary waveform and setting a start point for the waveform.

85. 3. 28
843771A

As this knob is turned in "→+" direction, the trigger level moves upward on the displayed waveform; as the knob is turned "←-", the level moves downward.

When set in the LOCK position, the trigger level is automatically maintained at an optimal value irrespective of the signal amplitude and for most signals requires no manual adjustment of the trigger level. When the signal level is at the trigger level, the TRIG'D LED (37) turns on.

When in the B END'S A mode, the A sweep ends at the same time the B sweep ends. With this function, degradation of brightness can be minimized when in the delayed sweep mode with large magnification of waveform in the horizontal direction.

LEVEL..... (51)
TRACE SEP (52)

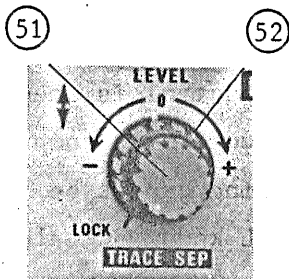

These double-knob controls are for level adjustment and trace separation adjustment. The functions of the LEVEL knob (51) are the same as those of the LEVEL knob (32). The function of the TRACE SEP knob is to control the vertical distance between A sweep and B sweep when in the ALT sweep mode.

843712

o Time Base

A, B TIME/DIV (39)
 AND DELAY TIME (40)

The large knob (39) is for A TIME/DIV and DELAY TIME, and the medium knob (40) is for B TIME/DIV.

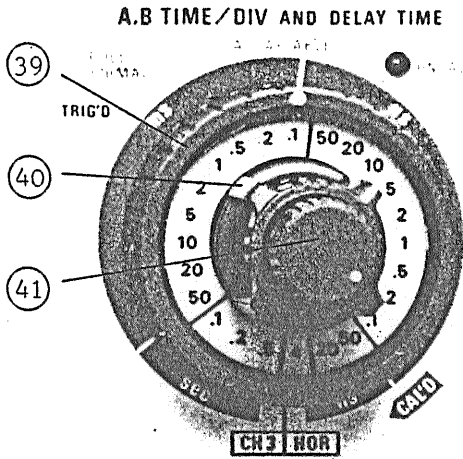

The A TIME/DIV knob sets the A sweep rate; the DELAY TIME knob sets the delayed sweep rate.

The B TIME/DIV switch sets the delayed sweep (B sweep) time.

When the TIME/DIV switch is set in the CH3 HOR position, the oscilloscope operates as a multichannel X-Y scope with CH3 channel as the X axis and other channels as the Y axis. (For details, see page 49.)

A VARIABLE (41)
 PULL x10 MAG

For continuously variable adjustment of A sweep rate and for x10 MAG function.

The value indicated by A TIME/DIV switch can be reduced by a factor of 2.5 or more. When set in the CAL'D position, the sweep speed is calibrated to the value indicated by the A TIME/DIV switch. When not in the CAL'D position, the UNCAL lamp (38) turns on.

When the knob is pulled out, the A or B sweep is expanded by 10 times.

85. 3. 28
 843773A

POSITION (44)

FINE (45)

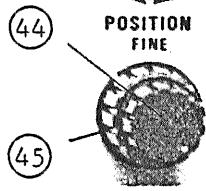

For horizontal positioning of spot or trace. The larger knob is for coarse adjustment and the smaller for fine adjustment.

DELAY TIME (47)

MULTI

Multi-turn potentiometer for continuously variable adjustment of the delay time indicated by the A sweep knob (39) in order to select the section to be expanded of the A sweep.

SWEEP MODE (30)

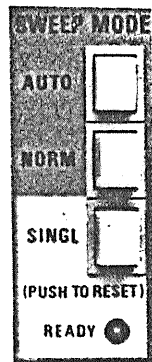

Selects the desired sweep mode.

AUTO: When no triggering signal is applied or when triggering signal frequency is less than 50 Hz, sweep runs in the free mode.

NORM: When no triggering signal is applied, sweep is in a ready state and the trace is blanked out. Used primarily for observation of signals of 50 Hz or lower.

SINGLE: Used for single sweep operation (one-shot sweep operation) in conjunction with the reset switch.

When the three buttons are in the pushed out state, the circuit is in the single sweep mode. The circuit is reset as

85.3.28
843774A

this button is pressed. When the circuit is reset, the READY lamp (42) turns on. The lamp goes off when the single sweep operation is over.

DISPLAY (29) Selects A and B sweep mode as follows:

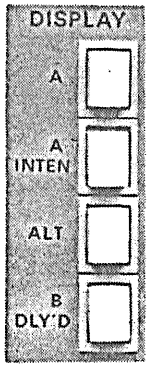

A: Main sweep (A sweep) mode for general waveform observation.

A INTEN: This sweep mode is used when selecting the section of the A sweep to be magnified for delayed sweep. The B sweep section (delayed sweep) is displayed with high brightness.

ALT: A INTEN sweep and B sweep (delayed sweep) are displayed alternately. (The A, B TRACE SEPARATION control (52) adjusts the distance between these traces.)

B: Displays the delayed sweep (B sweep) alone.

o Others

CAL (Vp-p)

(43) These terminals deliver the calibration voltage of approximately 1 kHz, positive square wave.

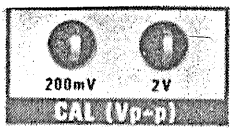

200 mV: Delivers 200 mVp-p signal. Output resistance approximately 200 Ω.

843775

2 V: Delivers 2 Vp-p signal.

Output resistance is approximately 2 k Ω .



.....

⑤③ Ground terminal of oscilloscope mainframe.

4.2 Explanation of Rear Panel (See Figure 4-2.)

o Z Axis

A AXIS INPUT ⑤④ Input terminals for external intensity modulation signal.

o Output Terminals

CH1 SIGNAL OUTPUT ... ⑤⑤ Delivers the CH1 signal with a voltage of approximately 10 mV per 1 DIV on screen (when terminated with 50 ohms). May be used for frequency counting, etc.

A GATE OUTPUT ⑤⑥ Delivers the A sweep gate signal. Output resistance is approximately 50 Ω .

A SWEEP OUTPUT ⑤⑦ Delivers the A sweep waveform signal. Output resistance is approximately 10 k Ω .

o Vertical Axes

CH4 POSITION ⑤⑨ Vertical positioning of the spot or trace of CH4 (A TRIG VIEW).

CH5 POSITION (60) Vertical positioning of the spot or trace of CH5 (B TRIG VIEW).

o AC Power Input Circuit

AC power input connector (61)
Input connector of the AC power of the instrument. Connect the AC power cord (supplied) to this connector.

FUSE (62) Fuse in the primary circuit of the power transformer. Fuse rating is as shown in Table (63)

AC voltage selecting connector (64)
For selecting the AC voltage of the instrument.

AC voltage selector plug (65)
For selecting the AC voltage of the instrument by aligning its arrowhead mark in the corresponding position as shown in Table (63)

843777

843718

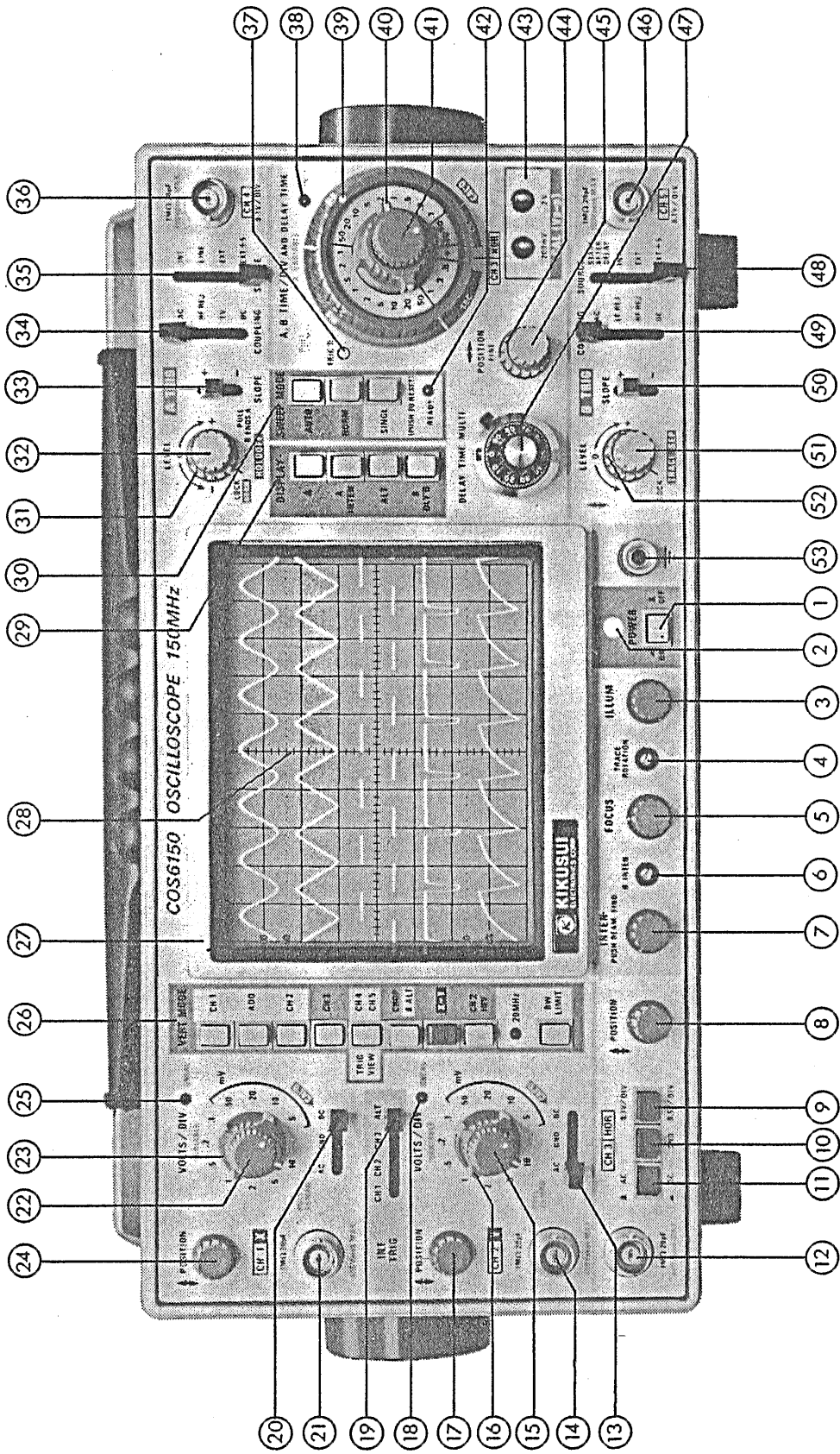

Figure 4-1

85.10.29

843779A

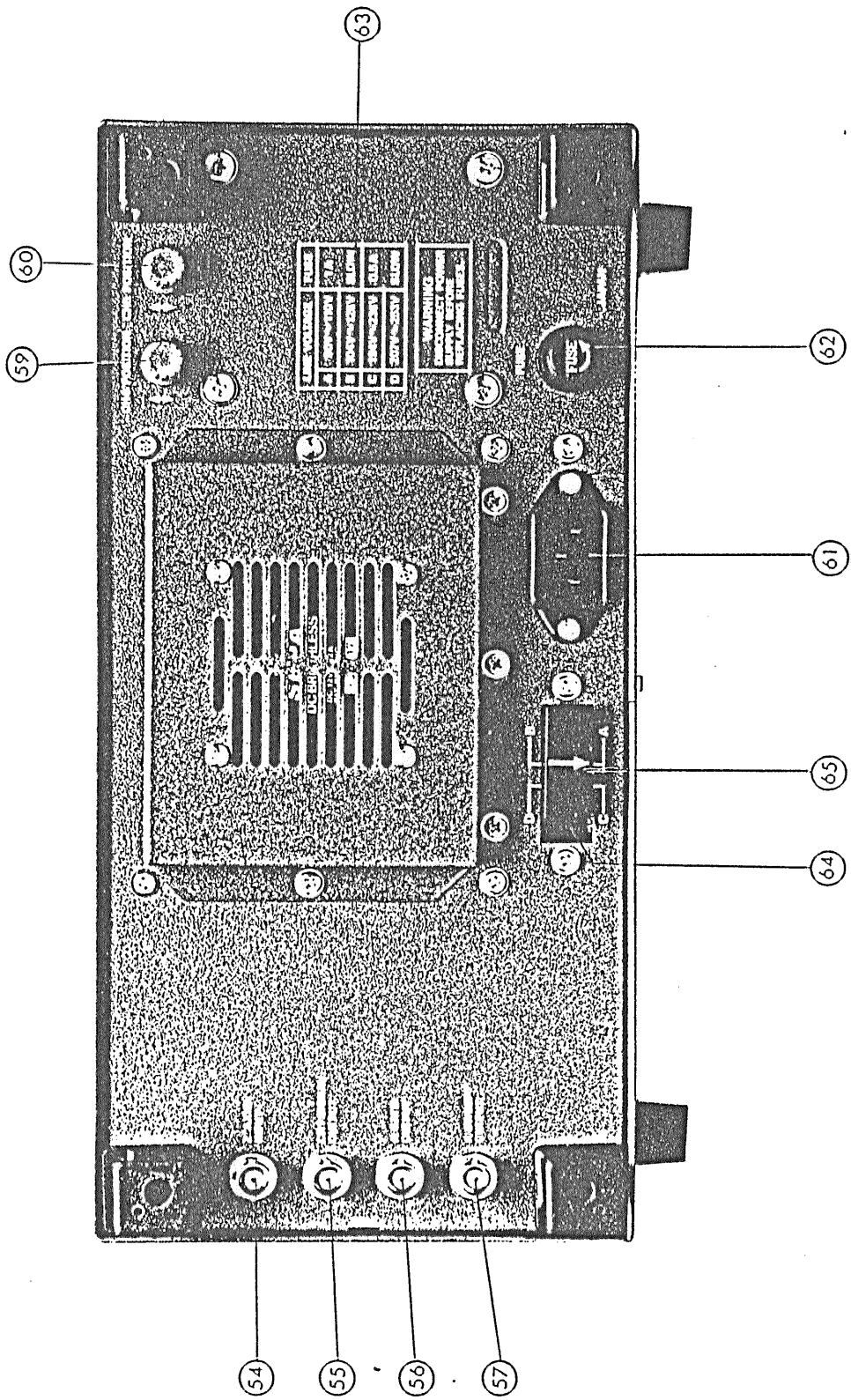

Figure 4-2

4.3 Basic Operation

Before connecting the power cord to an AC line outlet, check that the AC line voltage selector plug on the rear panel of the instrument is correctly set for the AC line voltage. After ensuring the voltage setting, set the switches and controls of the instrument as shown in the following table.

Item	No.	Setting
POWER	①	<input type="checkbox"/> OFF position
INTEN	⑦	Clockwise (3-o'clock position)
FOCUS	⑤	Mid-position
ILLUM	③	Counterclockwise position
VERT MODE	②⑥	All buttons in <input type="checkbox"/> state
↑ ↓ POSITION	⑧ ①⑦ ②④ ⑤⑨ ⑥⑩	Mid-position Mid-position (on rear panel)
VOLTS/DIV	①⑥ ②③	50 mV
VARIABLE (×5 MAG)	①⑤ ②②	CAL'D (clockwise position) Depressed state
AC-GND-DC	①③ ②⑦	GND
AC/DC	①①	<input type="checkbox"/> AC
/GND	①⑩	<input type="checkbox"/>
0.1V/0.5V	⑨	<input type="checkbox"/> 0.1V
INT TRIG	①⑨	ALT
SOURCE	③⑤ ④⑧	INT START AFTER DELAY
COUPLING	③④ ④⑨	AC
SLOPE	③③ ⑤⑩	+
LEVEL	③② ⑤①	LOCK (counterclockwise)

86 3. 28
8437800A

Item	No.	Setting
HOLDOFF	(31)	NORM (counterclockwise)
↕ TRACE SEP	(52)	Mid-position
SWEEP MODE	(30)	AUTO
DISPLAY	(29)	A
A, B TIME/DIV	(39) (40)	0.5 msec
VARIABLE ×10 MAG	(41)	CAL'D (clockwise position) Depressed state
↔ POSITION	(44)	Mid-position
(FINE)	(45)	Mid-position

After setting the switches and controls as above, connect the power cord to the AC line outlet and, then, proceed as follows:

- 1) Turn-ON the POWER switch and make sure that the power pilot LED above is turned on. In about 20 seconds, a trace will appear on the CRT screen. If no trace appears in about 60 seconds, verify the switch and control settings as shown in the above table.
- 2) Adjust the trace to an appropriate brightness and sharpest image with the INTEN control and FOCUS control.
- 3) Align the trace with the horizontal center line of graticule by adjusting the CH1 POSITION control and TRACE ROTATION control (screwdriver adjust).
- 4) Connect the probe (in the 10:1 division ratio, supplied) to the CH1 INPUT terminal, and apply the 200 mVp-p CALIBRATOR signal to the probe tip.

- 5) Set the AC-GND-DC switch in the AC state. A waveform as shown in Figure 4-3 will be displayed on the CRT screen.

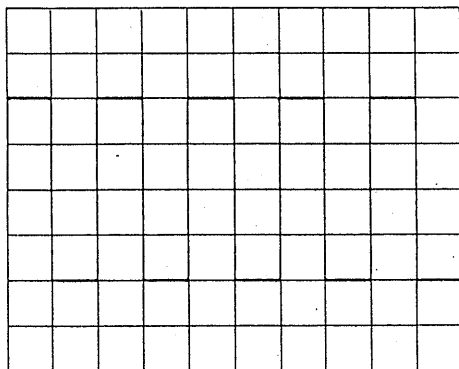

Figure 4-3

- 6) Adjust the FOCUS control so that the trace image becomes sharpest. No re-adjustment will be necessary as the linear focus circuit will automatically maintain the image in this best focussed state.
- 7) For signal observation, set the VOLTS/DIV switch and TIME/DIV switch in appropriate positions so that the signal waveform is displayed with an appropriate amplitude and an appropriate number of peaks.
- 8) Adjust the \updownarrow POSITION and \leftrightarrow POSITION controls in appropriate positions so that the displayed waveform is aligned with the graticule and the voltage (V_{p-p}) and period (T) can be read conveniently.

The above is the basic operating procedure of the oscilloscope. Further operation methods are explained in the subsequent paragraphs.

4.4 Vertical Mode Switches

The vertical mode switches of the oscilloscope are comprised of five types of mode selector switches as shown in the following:

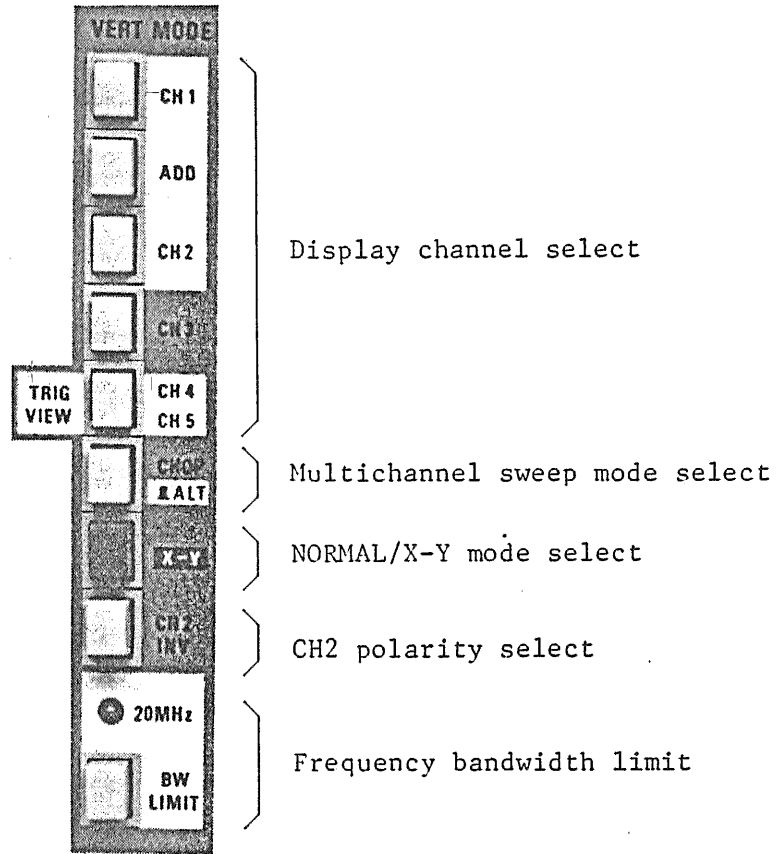

Figure 4-4

These mode switches can be set in any combination.

(1) Single-channel operation

For the signal-channel operation, depress one of the display channel buttons (□) and leave the remaining display channel buttons extended (□). If none of the display channel buttons are depressed (□), CH1 signal is displayed.

843783

Note: Either CH1, ADD (CH1 + CH2), CH2, CH3, or TRIG VIEW (CH4) can be viewed independently of each other. TRIG VIEW (CH5) may not be viewed independently of CH4.

(2) Multichannel operation

For multichannel operation, depress only the required display channel buttons and leave all other vertical mode buttons extended. Set the CHOP/ALT button in the CHOP or ALT mode as required.

When in the CHOP mode, the channel signals are chopped in sequence at a rate of about 1 μ sec (1 MHz). Multichannel traces are simultaneously displayed in a time-slicing method. When signal frequencies are high, the waveforms may be displayed with dotted lines. In such cases the ALT mode should be used.

When in the ALT mode, one channel is displayed for an entire sweep, then the next channel is displayed for an entire sweep. This mode is used primarily for display of high frequency signals at fast sweep speeds. At very low sweep speeds, signals are displayed alternately. In such cases the CHOP mode should be used.

Note: The multichannel operation can be done with any combinations of CH1, ADD (CH1 + CH2), CH2, CH3, and TRIG VIEW (CH4 and CH5). The last item means that the CH5 channel can be displayed only when the CH4 (TRIG VIEW) display is selected. The CH5 channel is displayed when the SOURCE switch (48) is set in the INT, EXT, or EXT ($\div 5$) position.

(3) X-Y operation

Simply by depressing the X-Y button, the oscilloscope operates as an X-Y scope. This button has the highest priority over all other vertical mode selector buttons. The X-Y operation is with CH1 as X axis and CH2 as Y axis. The bandwidth of the X axis is DC to 5 MHz (-3 dB) and the CH1 POSITION control (24) is used as the X axis (\leftrightarrow) POSITION control. Other electrical performances remain the same as when the circuit is used as the CH1 vertical channel. The Y axis operates with the same electrical performances as when the circuit is used as the CH2 vertical channel, and its operation method remains the same.

When the calibration voltage signal is applied to the input terminals of both X and Y axis with the probes (in the 10:1 division ratio, supplied) and the corresponding VOLTS/DIV switches are properly adjusted, a Lissajous figure as shown in Figure 4-5 will be displayed.

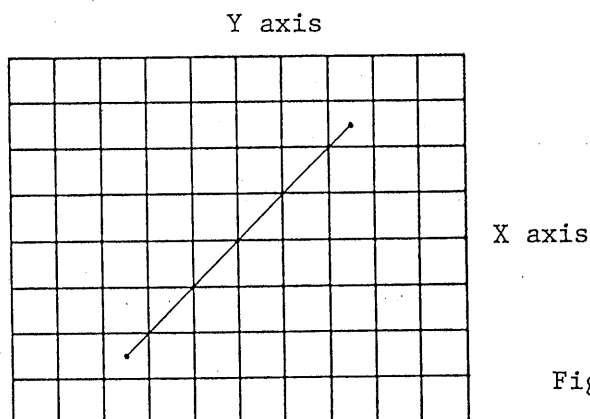

Figure 4-5

Note: When high frequency signals are displayed in the X-Y operation, pay attention to the frequency bandwidths of and phase difference between X and Y axes.

843785

(4) ADD operation

An algebraic sum of the CH1 and CH2 signals can be displayed on the screen by depressing the ADD switch. The displayed signal is the difference between CH1 and CH2 signals if the CH2 POLARITY switch is set in the INV () state.

For accurate addition or subtraction, it is a prerequisite that the sensitivities of the two channels are adjusted accurately to the same value. Vertical positioning can be done with the \updownarrow POSITION knob of either channel. In view of the linearities of the vertical amplifiers, it is most advantageous to set them in their mid-positions.

(5) BW LIMIT mode

When the BW LIMIT button is depressed (), a bandpass filter of approximately 20 MHz is inserted in the vertical amplifier. When in this mode of operation, higher frequency components and noise components are eliminated from the displayed signal. Another advantage of this mode is that the internal noise components are eliminated and consequently a clear waveform is displayed. This mode is suitable for use at lower frequencies.

4.5 CH3 HOR Operation

When the A TIME/DIV switch is set in the CH3 HOR position, the oscilloscope operates as a multichannel X-Y scope with the channels (except CH3) selected by the vertical mode switches as the Y axis and CH3 as the X axis. The bandwidth of the X axis becomes DC - 5 MHz (-3 dB). The vertical (\updownarrow) POSITION knob (8) can be used as the horizontal (\leftrightarrow) POSITION knob. Other electrical performances are the same as CH3. Regarding the Y axis, the channels selected by the vertical mode switches are displayed in the CHOP mode, with the electrical performances and the operation method remaining the same.

4.6 Triggering

Proper triggering is essential for efficient operation of an oscilloscope. The user of the oscilloscope must make himself thoroughly familiar with the triggering functions and procedures.

(1) Functions of INT TRIG (internal trigger) switch:

The signals applied to the input terminals of CH1, CH2 and CH3 are picked off from respective preamplifiers in order to be used as internal trigger signals. The INT TRIG switch selects these signals. The selected signals are sent to the A trigger circuit or the B trigger circuit through the SOURCE switch. The relationships of these circuits are shown in the block diagram of Figure 4-6.

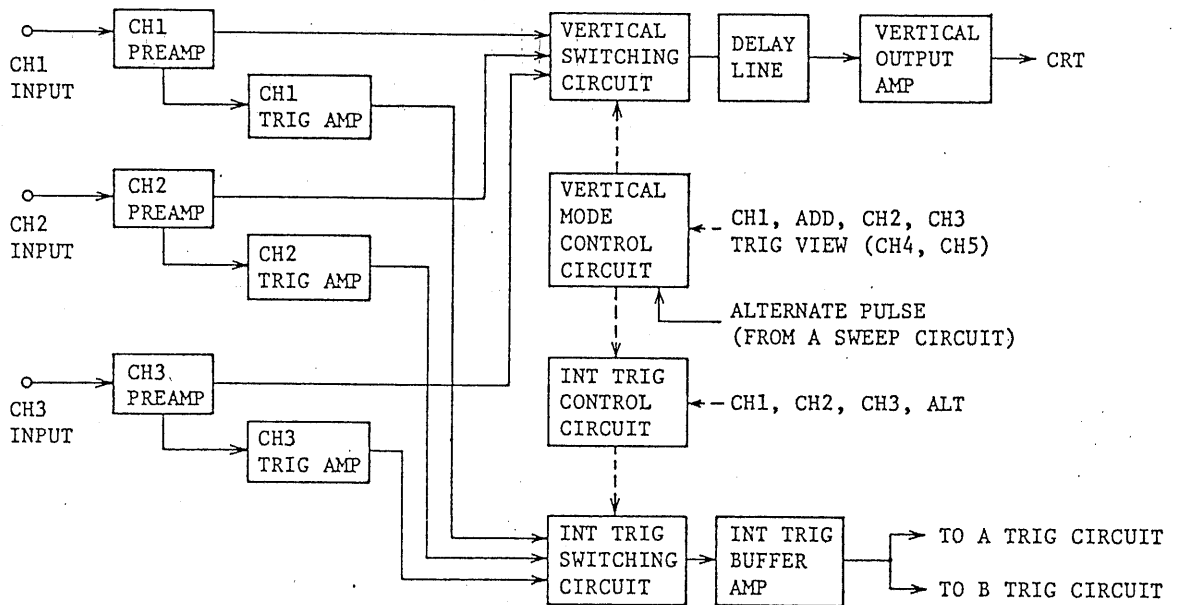

Figure 4-6

843787

With the INT TRIG switch the internal trigger signal can be selected as follows.

- CH1: Input signal of CH1
- CH2: Input signal of CH2
- CH3: Input signal of CH3
- ALT: All signals being displayed on screen

As can be seen in the block diagram, the triggering circuits are designed with certain relationships to the vertical mode selector switches. These relationships are shown in the following table.

INT TRIG / MODE	CH1	ADD	CH2	CH3	TRIG VIEW	
					CH4	CH5
CH1	Trig by CH1					
CH2	Trig by CH2					
CH3	Trig by CH3					
ALT	Trig by CH1	Trig by CH1	Trig by CH2	Trig by CH3	(Trig by CH1)	(Trig by CH1)

The items enclosed in the parentheses are for the TRIG VIEW (INT TRIG) mode.

- Notes:
1. When in the ALT mode, two or more signals of CH1, CH2 and CH3 use the same trigger circuit alternately. Therefore, These signals must cross the same trigger level. Pay attention to the DC components of these signals. It is necessary to use TRIG LEVEL knob (21) and DC coupling mode for best triggering.
 2. Note that jitter may be produced when the sweep speed is slow if the SOURCE switch is set for AC coupling.
 3. The ALT trigger function for vertical modes is effective only when in the single-channel operation and when in the ALT-mode multichannel operation. It is not effective when in the CHOP mode.
 4. 3 cycles or more on the C.R.T must be displayed to obtain observation of complete triggering signal.

843788

(2) Function of SOURCE Switch:

To display a stationary pattern on the CRT screen, the displayed signal itself or a trigger signal which has a time relationship with the displayed signal is required to be applied to the trigger circuit. The SOURCE switch selects such a trigger source.

INT: This internal trigger method is used most commonly. The signal applied to the vertical input terminal (the measured signal) is branched off from a point in the amplifier circuit and is fed to the trigger circuit through the INT TRIG switch. Since the trigger signal is the measured signal itself, a very stable waveform can be readily displayed on the CRT screen.

LINE: The AC power line frequency signal is used as the trigger signal. This method is effective when the measured signal has a relationship with the AC line frequency, especially for measurements of low level AC noise of audio circuits, thyristor circuits, etc.

EXT: The sweep is triggered with an external signal applied to the external trigger input terminal (CH4 or CH5). An external signal which has a periodic relationship with respect to the measured signal is used. Since the measured signal (vertical input signal) is not used as the trigger signal, the waveform display can be done independent of the measured signal. (Select CH4 or CH5 input signal.)

EXT ÷ 5: The external trigger signal applied to the external trigger input terminal is attenuated into 1/5 before being applied to the trigger circuit. Operation is the same with those of the EXT trigger mode. This mode is used when the external trigger signal level is too high.

843789

START AFTER DELAY: This position is for continuous sweep delay (B sweep) mode. When in other position (INT or EXT ($\div 5$)), the sweep runs in the triggered delay mode. (When in the START AFTER DELAY position, the CH5 signal is not displayed if the vertical mode selector switch is set in the TRIG VIEW position.)

(3) Functions of COUPLING switch:

This switch is used to select the coupling of the trigger signal to the trigger circuit in accordance with the characteristics of the measured signal.

AC: This coupling is for AC triggering which is used most commonly. As the trigger signal is applied to the trigger circuit through an AC coupling circuit, stable triggering can be attained without being affected by the DC component of the input signal. The low-range cut off frequency is 3 Hz (-3 dB).

When the ALT trigger mode is used and the sweep speed is slow, jitter may be produced. In such a case, use the DC mode.

LF REJ: The trigger signal is fed to the trigger circuit through an AC coupling circuit and a high pass filter (approximately 50 kHz, -3 dB). The DC component, AC noise and other low frequency components are rejected. Only the higher frequency components of the trigger signal are applied to the trigger circuit.

HF REJ: The trigger signal is fed to the trigger circuit through an AC coupling circuit and a low pass filter (approximately 50 kHz, -3 dB). The higher frequency components of the trigger signal are rejected. Only the lower frequency components of the trigger signal are applied to the trigger circuit.

843790

This feature is used for more stable triggering when the triggering signal has large noise or when the oscilloscope is set at a high sensitivity thereby making triggering unstable.

TV: This coupling is triggering of TV video signals. The trigger signal is AC-coupled and fed via the trigger circuit (level circuit) to the TV sync separator circuit. The separator circuit picks off the sync signal, which is used to trigger the sweep. Thus, the video signal can be displayed very stably.

Being linked to the TIME/DIV switch, the sweep speed is switched for TV.V and TV.H as follows:

TV.V: 0.5 sec - 0.1 msec

TV.H: 50 μ sec - 20 nsec

The SLOPE switch should be set in conformity with the video signal as shown in Figure 4-7.

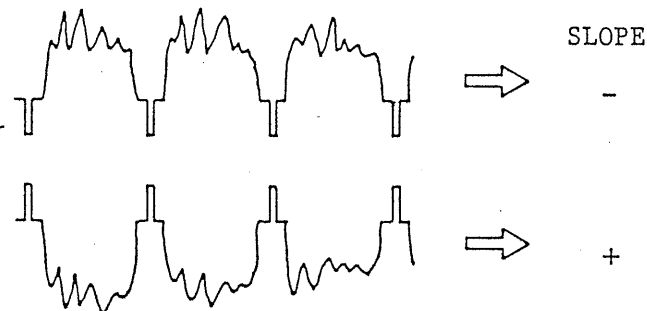

Figure 4-7

DC: The trigger signal is DC-coupled to the trigger circuit. This mode is used when triggering on a DC component of a signal or when triggering on very low frequency signals.

4419507

85. 4. 3

843791.1

(4) Functions of SLOPE switch:

This switch selects the slope (polarity) of the trigger signal.

"+": When set in the "+" state, triggering occurs as the trigger signal crosses the trigger level in the positive-going direction.

"-": When set in the "-" state, triggering occurs as the trigger signal crosses the trigger level in the negative-going direction.

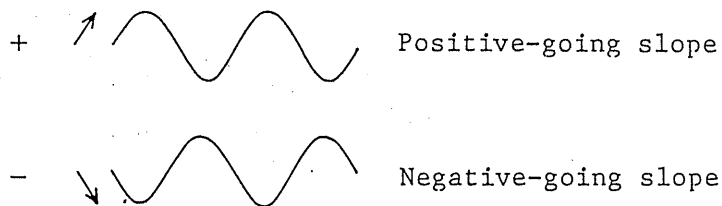

Figure 4-8

(5) Functions of LEVEL (LOCK) control:

The function of this control is to adjust the trigger level and display a stationary image. At the instant the trigger signal has crossed the trigger level set by this control, the sweep is triggered and a waveform is displayed on the screen.

The trigger level changes in the positive direction (upward) as this control knob is turned clockwise and it changes in the negative direction (downward) as the knob is turned counterclockwise. The rate of change is set as shown in Figure 4-9.

843792

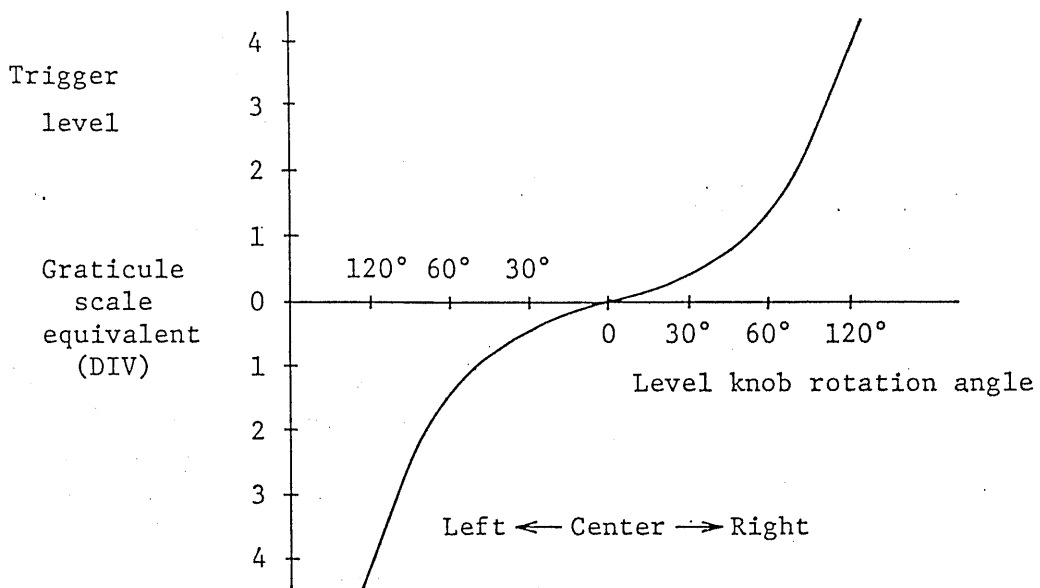

Figure 4-9

o LEVEL LOCK

When the LEVEL knob is set in the LEVEL LOCK position, the trigger level is automatically maintained within the amplitude of the trigger signal and stable triggering can be done without requiring level adjustment (although jitter may not be suppressed when in the ALT mode). This automatic level lock function is effective when the signal amplitude on the screen or the external trigger input voltage is within the following range:

50 Hz - 20 MHz: 0.9 DIV (0.09 V) or less

50 Hz - 100 MHz: 2.0 DIV (0.2 V) or less

(6) Functions of A HOLDOFF control:

When the measured signal is a complex waveform with two or more repetition frequencies (periods), triggering with the above-mentioned LEVEL control alone may not be sufficient

843793

for attaining a stable waveform display. In such a case, the sweep can be stably synchronized to the measured signal waveform by adjusting the HOLDOFF time (sweep pause time) of the sweep waveform. The control covers at least the time of one full sweep, for sweeps faster than 0.2 sec/DIV.

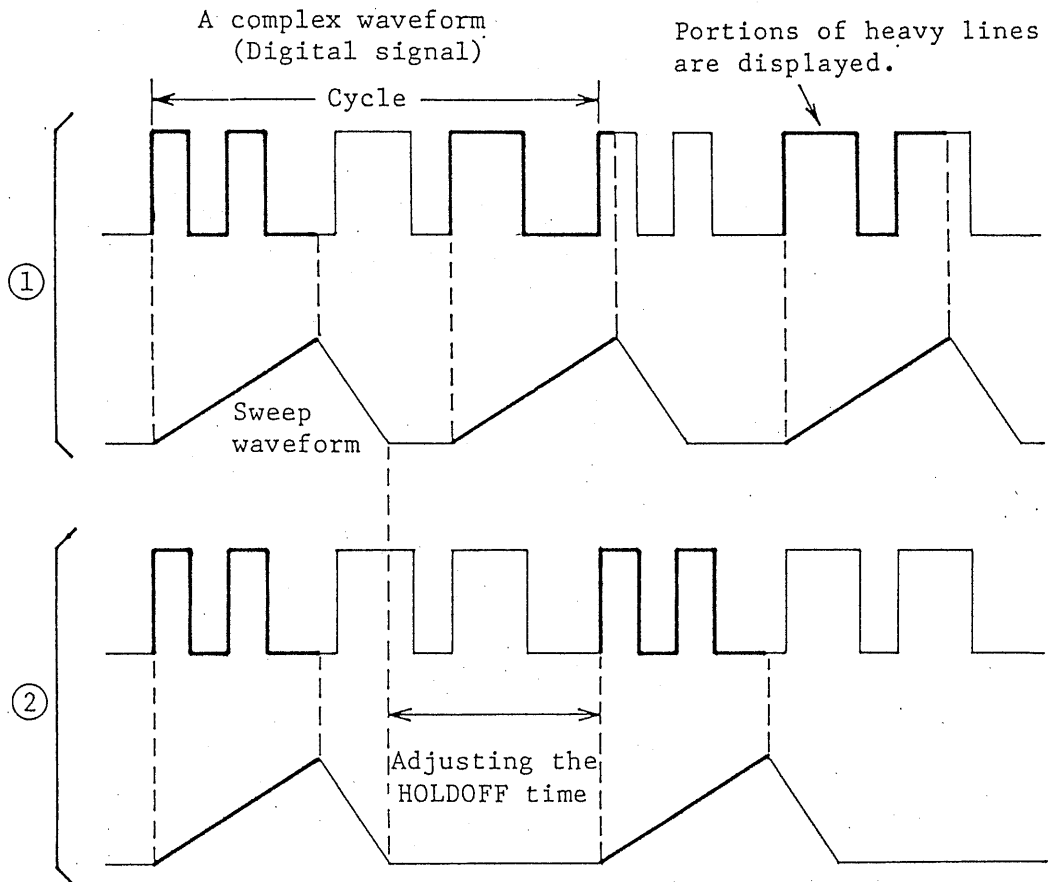

Figure 4-10

Figure 4-10 ① shows a case where the HOLDOFF knob is in the NORM state and various different waveforms are overlapped on the screen, making the signal observation unsuccessful.

Figure 4-10 ② shows a case where the undesirable portion of the signal is with held and the same waveforms are displayed on the screen.

843794

4.7 Single-sweep Operation

Non-repetitive signals and one-shot transient signals can hardly be observed on the screen. Such signals can be measured by displaying them in the single-sweep mode on the screen and photographing them.

o Measurement of non-repetitive signal:

- (1) Set the DISPLAY in the "A" state and the SWEEP MODE in the NORM state.
- (2) Apply the measured signal to the vertical input terminal and adjust the trigger level.
- (3) Set the SWEEP MODE in the SINGLE state (the three push-button switches are up).
- (4) Press the RESET button. The sweep will run only for one cycle and the measured signal will be displayed only once on the screen.

o Measurement of one-shot signal:

- (1) Set the DISPLAY in the "A" state and the SWEEP MODE in the NORM state.
- (2) Apply the calibration output signal to the vertical input terminal, and adjust the trigger level to a value corresponding to the predicted amplitude of the measured signal.
- (3) Set the SWEEP MODE in the SINGLE state. Apply the measured signal instead of the calibration signal to the vertical input terminal.
- (4) Depress the RESET button. The sweep circuit will become the ready state and the READY lamp will turn on.

- (5) As the one-shot signal occurs in the input circuit, the sweep runs only for one cycle and the one-shot signal is displayed on the CRT screen.

The single-sweep operation can be done also with A INTEN B sweep. However, it cannot be done in the multichannel ALT mode operation. For multichannel one-sweep operation, use the CHOP mode.

4.8 Sweep Magnification

When a certain part of the displayed waveform needs to be magnified, a faster sweep speed (MAG) may be used. In such a case, pull out the sweep VARIABLE knob (41) (set in the $\times 10$ MAG state). When this is done, the displayed waveform is expanded by 10 times. The center of the waveform will be displayed. Any part can be covered by means of POSITION control.

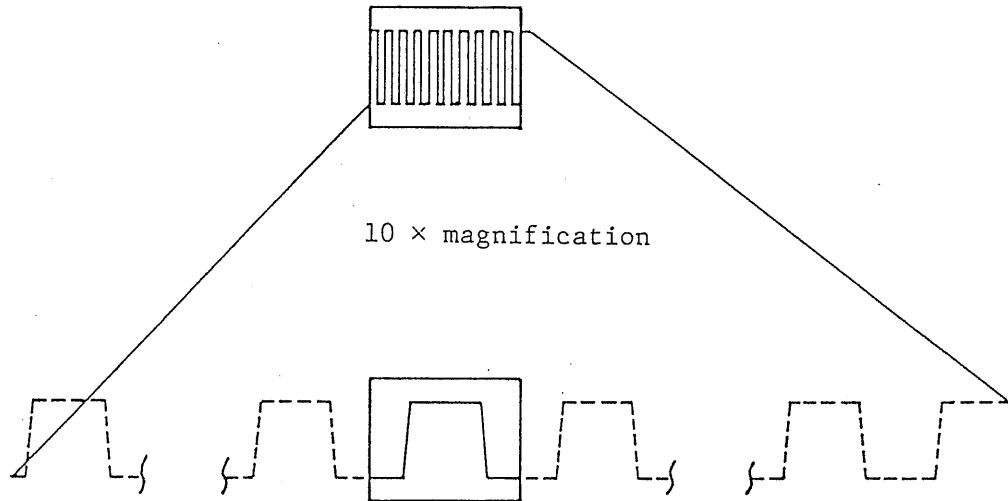

Any part can be covered by means of POSITION control.

Figure 4-11

843796

When the sweep is magnified and the sweep speed has become faster than 20 nsec/DIV, the trace intensity may be reduced. In such a case, the displayed waveform should be expanded in the B sweep mode explained in the subsequent paragraphs.

4.9 Waveform Magnification with Delayed Sweep

With sweep magnification (described above), the magnification ratio is limited to 10 \times . With the delayed sweep method, the sweep can be expanded for a wide range of from several times to several thousand times depending on ratio between A sweep time and B sweep time.

As the measured signal frequency becomes high and the A sweep range for the non-expanded signal becomes higher, the available expansion ratio becomes smaller. Furthermore, as the magnification ratio becomes larger, the trace intensity becomes lower and the delay jitter increases. To cope with this situation, a triggered delay circuit and a B ENDS A circuit are provided.

(1) Continuous delay:

Set the DISPLAY switch to A and display the signal waveform with the A sweep in the regular operation method.

Next, set the B TIME/DIV switch to a position faster than that of the A TIME/DIV switch.

After ensuring that the SOURCE switch (48) is set in the START AFTER DELAY state, turn the DISPLAY switch to the A INTEN position. A part of the displayed waveform will be accentuated as shown in Figure 4-12, indicating the state ready for delayed sweep. The intensified portion denotes the section corresponding to the B sweep time (DELAYED SWEEP).

843797

The period from the start of the A sweep to the beginning of B sweep (the accentuated portion of the trace) is called "SWEEP DELAY TIME". This period is continuously variable by means of the DELAY TIME MULTI dial.

Next, change the DISPLAY switch to the B position. The B sweep time will be expanded to a full sweep (10 cm) as shown in Figure 4-13.

The B sweep time is set by the B TIME/DIV switch and the magnification ratio becomes as follows:

$$\text{Magnification ratio} = \frac{\text{A TIME/DIV indication}}{\text{B TIME/DIV indication}}$$

The sweep delay time can be read on the CRT screen. For more accurate determination, the DELAY TIME MULTI dial should be used.

$$\text{Sweep delay time} = \text{A TIME/DIV indication} \times \text{DELAY TIME MULTI dial setting}$$

HORIZ DISPLAY
A INTEN

Figure 4-12

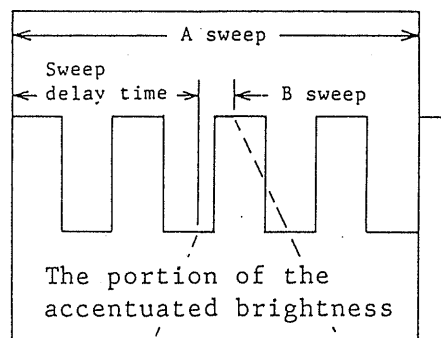

HORIZ DISPLAY
B

Figure 4-13

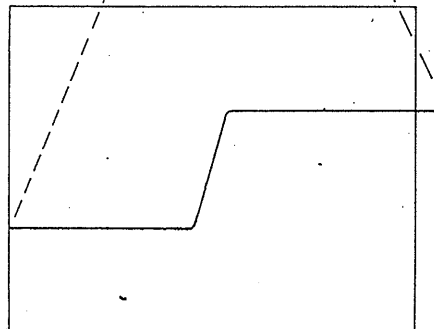

843798

(2) Triggered delay:

When the displayed waveform is magnified by 100 times or more by the continuous delay method, delay jitter is produced. To suppress the jitter, a triggered delay method may be used.

For this operation, the B trigger circuit operates when the SOURCE switch (48) is set in the INT state and the B sweep is triggered by the B trigger pulse. Therefore, even when the delay time is continuously varied by rotating the DELAY TIME MULTI dial, the starting point does not vary continuously but varies intermittently. This operation when in the A INTEN mode can be observed as the intensified section jumps from trigger point to trigger point on the A sweep waveform.

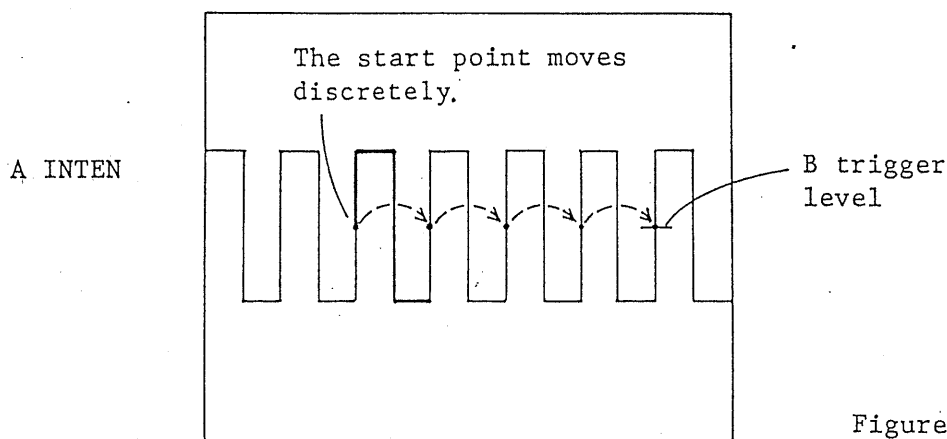

Figure 4-14

4.10 Delayed ALT Sweep

When in the Delayed ALT sweep mode, the A sweep and B sweep (delayed sweep) are displayed alternately on the screen, enabling you to observe at the same time the unmagnified waveform and magnified section.

To prevent the two waveforms from overlapping and to display them separately, adjusted the TRACE SEP control (52).

843799

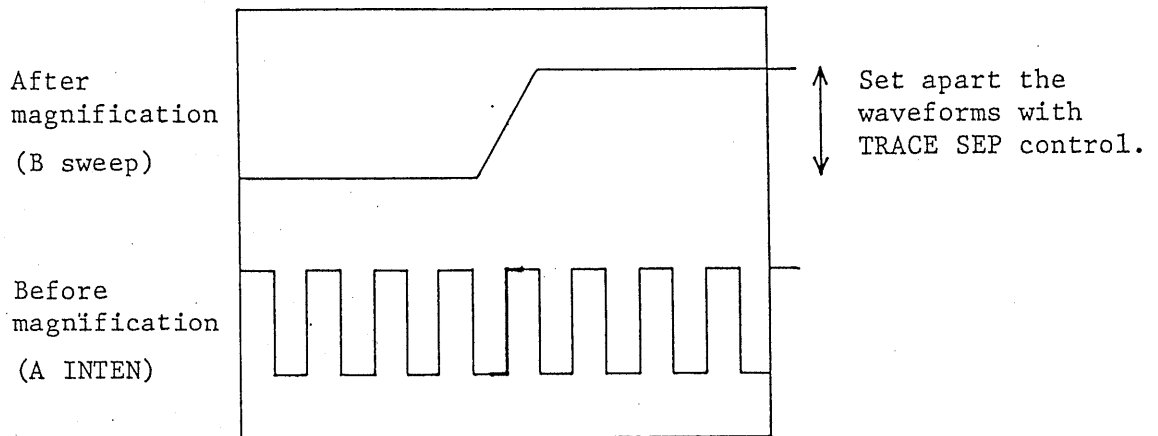

Figure 4-15

Note: The delayed ALT sweep mode can be used in combination with the multichannel mode (CHOP or ALT) of the vertical axes.

4.11 B ENDS A Mode

When the trace is magnified by a large ratio with the delayed sweep, the magnified trace may become dim and hardly discernible. By ending the A sweep at the minimum required point, the display time for the B sweep is increased so that the trace does not become dim. The B ENDS A mode should be used.

The operating method is the same as that of Subsections 4.9 and 4.10. Pull out the LEVEL knob (32) to set it in the B END A state, and a bright magnified trace shown in Figure 4-16 will be displayed.

Turn the A HOLD OFF knob (31) to the extreme clockwise position (B ENDS A position). A bright magnified trace as shown in Figure 4-16 will be displayed.

843800

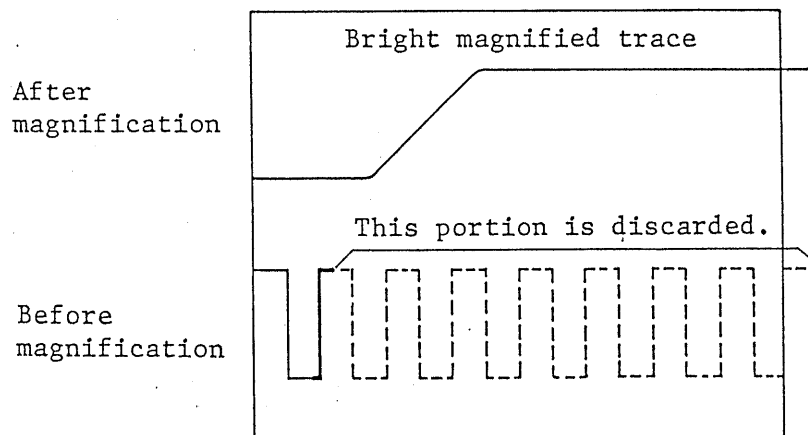

Figure 4-16

5. MEASURING METHODS

5.1 Connection Method of Input Signal

The input impedance of the oscilloscope as viewed from the vertical input terminal is 1 MΩ with capacitance approximately 20 pF in parallel. When the probe 10:1 is used, the impedance increases to resistance 10 MΩ with capacitance approximately 13 pF in parallel.

There are various methods of connecting the signal sources to the oscilloscope. The most popular methods are with regular covered wires, with shielded wires, with a probe, or with a coaxial cable. The following factors should be considered.

Output impedance of input signal source

Level and frequency of input signal

External induction

Distance between the input signal source and the oscilloscope

Types of input signals and connection methods are tabulated in the following:

Type of input signal		Connection method		Probe	Coaxial cable
		Near	Far		
Low frequency	Low impedance	Near		○	○
		Far			○
	High impedance	Near		○	⊗
		Far			⊗
High frequency	Low impedance	Near		○	○
		Far			○
	High impedance	Near		○	⊗
		Far			

(○: Good, ⊗: Fair)

o Connection with coaxial cable:

When the output impedance of the signal source is 50Ω or 75Ω , the input signal can be fed without attenuation by using a coaxial cable which enables impedance matching.

For impedance matching, terminate the coaxial cable with a 50Ω or 75Ω pure-resistive resistor corresponding to the characteristic impedance of coaxial cable, as shown in Figure 5-1.

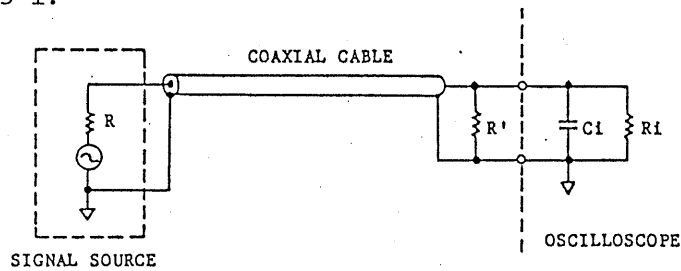

$$R = R'$$

When $R = 50\Omega$, use a 50Ω coaxial cable.

When $R = 75\Omega$, use a 75Ω coaxial cable.

Figure 5-1

o Connection with probe:

Two probes with an attenuation ratio of 10:1 are supplied. The probe circuit and probe cable are shielded to prevent induction noise. The probe circuit makes up a wide-range attenuator in conjunction with the input circuit of the oscilloscope, thereby enabling a distortionless connection from DC to high frequencies. When the probe is used, although the signal level is attenuated to 1/10, the input impedance becomes very high (resistance $10\text{ M}\Omega$, capacitance approx. 13 pF) and the loading effect on the measured signal source is greatly reduced as explained in the following.

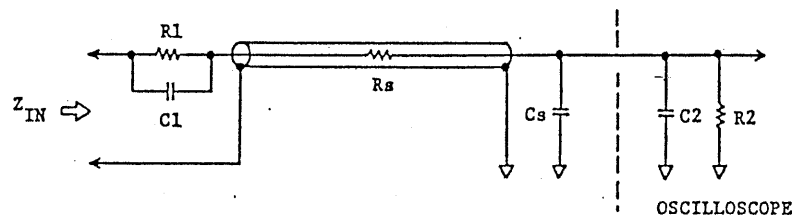

R_s = Series resistance of cable

C_s = Stray capacitance plus cable capacitance

Figure 5-2

843805

The probe makes up an attenuator with resistor R1, in the probe, and the input resistor R2, in the oscilloscope. Capacitor C1 compensates for input capacitor C2 in the oscilloscope and stray capacitance (Cs) in the cable. The input impedance Z_{IN} is expressed as follows:

$$Z_{IN} = \frac{R1 + R2}{\omega C (R1 + R2) + 1}$$

$$C = \frac{C1 \times (C2 + Cs)}{C1 + C2 + Cs}$$

Attenuation ratio A is expressed as follows:

$$A = \frac{R2}{R1 + R2} \quad \left(= \frac{1 \text{ M}\Omega}{9 \text{ M}\Omega + 1 \text{ M}\Omega} = \frac{1}{10} \right)$$

The terms enclosed in the parentheses are for the factor when the probe is used:

Precautions:

- o Observe the maximum allowable input voltages mentioned in Section 3.5.
- o Do not fail to use the ground lead supplied.
- o Before taking measurement, accurately adjust the frequency compensation of the probe without fail.
- o Do not apply large mechanical shocks or vibration to the probe. Do not sharply bend or strongly pull the probe cable.
- o The probe unit and tip are not highly heat resistant. Do not apply a soldering iron to a circuit close to the point where the probe is attached.

843804

5.2 Voltage Measurement

To measure the AC portion of a signal which has DC superimposed on the AC component, set the vertical input AC/DC selector switches (13) and (20) in the AC position. To measure the DC component of a signal, set the switch in the DC position.

Before commencing voltage measurement, set the VARIABLE attenuator knobs (15) and (22) at the CAL'D position and calibrate the sensitivity to the value indicated by the VOLTS/DIV selector switches (16) and (23).

Apply the signal to be measured, display the signal with an appropriate amplitude on the screen, and determine the amplitude on the graticule. For DC voltage measurement, determine the shifted distance of the trace. The voltage can be determined as follows:

- (1) When measured signal is directly applied to input terminal:

$$\text{Voltage (V)} = \text{Deflection amplitude (DIV)} \times \text{VOLTS/DIV}$$

- (2) When the 10:1 probe is used:

$$\text{Voltage (V)} = \text{Deflection amplitude (DIV)} \times \text{VOLTS/DIV} \times 10$$

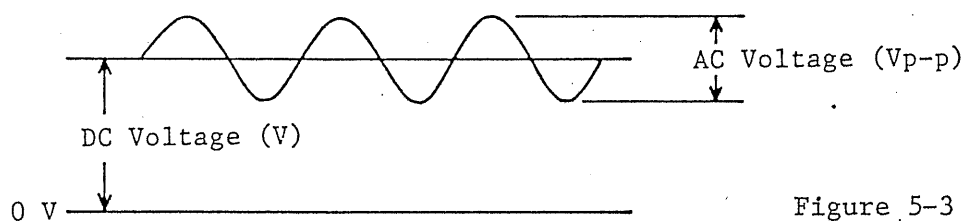

5.3 Current Measurement (voltage drop method)

Connect a small resistor (R) in series in the circuit in which the current (I) to be measured flows and measure the voltage drop across the resistor with the oscilloscope. The current is known from Ohm's law as follows:

$$I = \frac{E}{R} \quad (\text{A})$$

843805

The resistance should be as small so possible it does not cause change to the measured signal source.

In the above method, currents from DC to high frequencies can be measured quite accurately. Note that the accuracy of the resistor reflects upon the measuring accuracy.

5.4 Time Measurement

Measurement of time interval

The time interval between any two points on the displayed waveform can be measured by setting the TIME/DIV VARIABLE knob (41) in the CAL'D position and referring to the indication of the TIME/DIV switch (39).

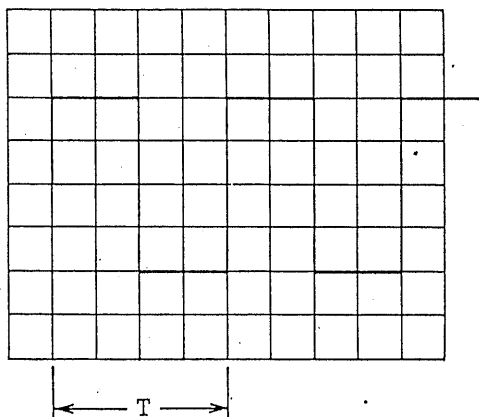

Figure 5-4

$$\text{Time T (sec)} = \text{Indication of TIME DIV} \times \text{Horizontal span (DIV)}$$

When the sweep is magnified ($\times 10$ MAG (41) pulled), the time is 1/10 of the value determined as above.

5.5 Frequency Measurement

- o Frequency measurement by determining time (T) per one cycle of the displayed waveform:

Time T (period) is measured as explained in section 5.4 and the frequency is known by using the following formula.

$$\text{Frequency } f \text{ (Hz)} = \frac{1}{\text{Period T (sec)}}$$

- o Frequency measurement with Lissajous figure (See Figure 5-5 and 5-6):
Set the MODE switch (21) in the X-Y state so that the oscilloscope operates in the X-Y mode.

843806

Apply to the X-axis a known frequency from a signal generator (SG) and to the Y-axis the frequency to be measured. Adjust the required controls so that a pattern is displayed on the full surface of the CRT screen. Then adjust the frequency of the signal generator so that the displayed pattern becomes stationary as shown in Figure 5-4. From the displayed waveform, the unknown frequency can be calculated as follows:

$$\text{Unknown Frequency (Hz)} = \frac{\text{The number of crossing points over horizontal scale line}}{\text{The number of crossing points over vertical scale line}} \times \text{Frequency of signal generator (Hz)}$$

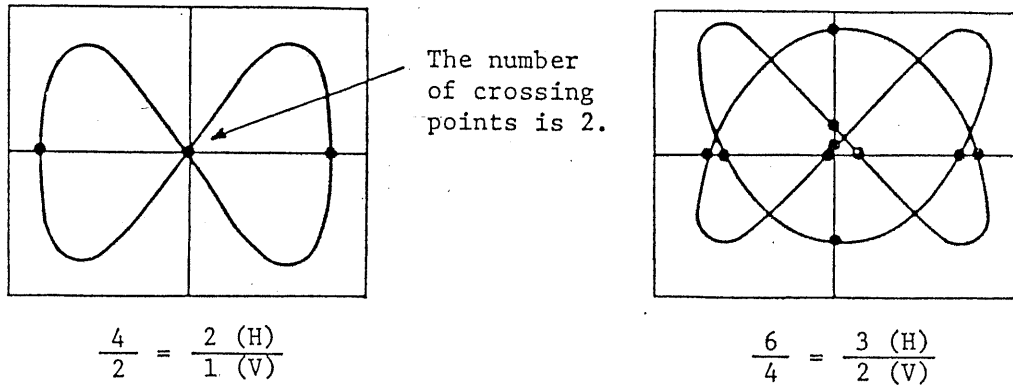

Figure 5-5

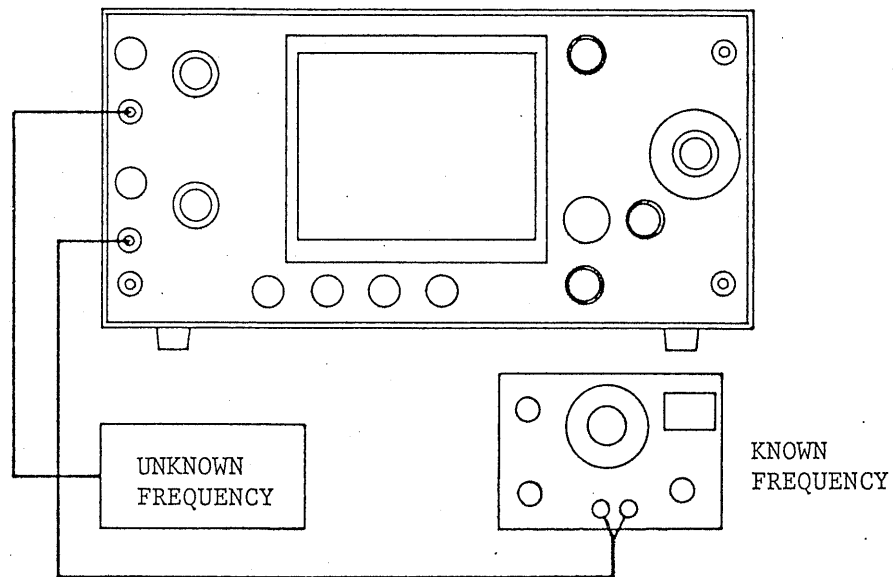

Figure 5-6

843807

5.6 Measurement of Phase Difference

- o Measurement of phase difference with Lissajous figure
(See Figures 5-6, 5-7 and 5-8):

Operate the oscilloscope in the X-Y mode as explained in the paragraph for frequency measurement, and apply two signals of the same frequency (such as stereophonic signals) to the X and Y axes so that a Lissajous figure is displayed on the CRT screen. The phase difference between the two signals can be known by measuring the displayed waveform and employing the following equation:

$$\text{Phase difference } \theta = \sin^{-1} \frac{B}{A}$$

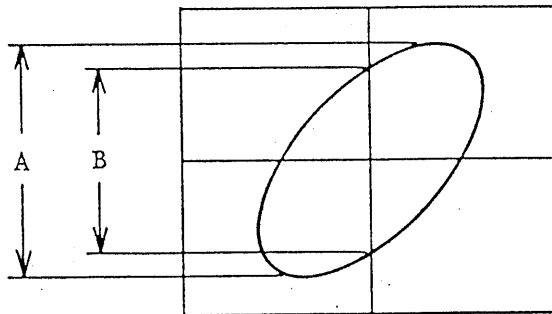

Figure 5-7

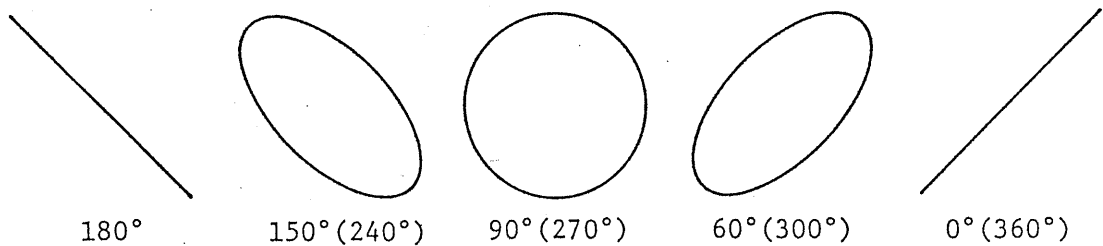

Figure 5-8

5.7 Characteristics of Pulse Waveform

A theoretically ideal pulse waveform is such that the signal changes instantaneously from one level to another, held in this level for a period of time and returns instantaneously to the original level. However, actual pulse waves are distorted. Nomenclature of distortions is given in Figure 5-9.

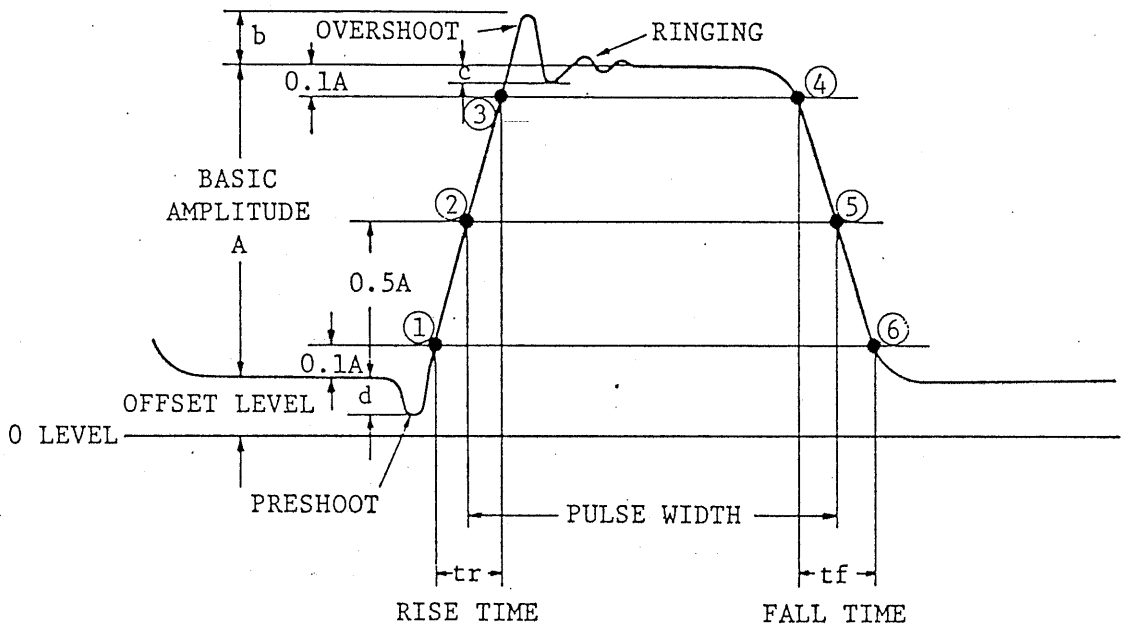

Figure 5-9.

Pulse amplitude: Basic amplitude (A) of pulse

Pulse width: Time between points ② and ⑤ where signal amplitude is 50% of basic amplitude

Rise time: Time between 10% basic amplitude point ① and 90% basic amplitude point ③

Fall time: Time between 90% basic amplitude point ④ and 10% basic amplitude point ⑥

843809

Overshoot: Amplitude of the first maximum excursion beyond basic amplitude. Expressed in terms of $b/A \times 100$ (%)

Ringings: Oscillation which follows the first maximum excursion. Expressed in terms of $c/A \times 100$ (%)

Preshoot: Amplitude change (rise or fall) which precedes rise up of main pulse. Expressed in terms of $d/A \times 10$ (%)

Hole: Amplitude fall that occurs after rise up of main pulse. Expressed in terms of $e/A \times 100$ (%)

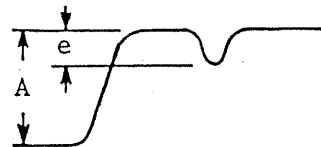

Bump: Amplitude rise that occurs after rise up of main pulse. Expressed in terms of $f/A \times 100$ (%)

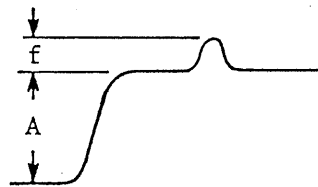

(Refer to EIAJ MEA-27A or IEC PUB. 351-1.)

o Measurement of rise time:

The rise time of a pulse can be known by determining the value of t_r on the CRT screen in the method of "Time Measurement." It must be noted that t_r determined on the CRT screen includes the rise time of the oscilloscope itself. The closer the rise time of the oscilloscope (t_o) to the rise time of the measured pulse (t_n), the larger is the error introduced. To eliminate this error, calculation should be done as follows:

843810

$$\text{True rise time } t_n = \sqrt{(t_r)^2 - (t_o)^2}$$

where, t_r : Rise time measured on CRT screen

t_o : Rise time of oscilloscope itself

(approx. 3.5 nsec)

For example, when a pulse wave with a rise time of 10 nsec (about 3 times that of the oscilloscope) is measured on the CRT screen, the error is approximately 6%.

o Measurement of Sag

Pulse waveforms may have slanted sections as shown in Figure 5-10, in addition to those distortions mentioned in Figure 5-9. Slants are caused when the signal is amplified with an amplifier which has poor low-frequency characteristics, resulting from attenuation of low frequency components. The slanted section (d or d') is called "sag" and is calculated as follows:

$$\text{Sag} = \frac{d}{A} \quad (\text{or } \frac{d'}{A'}) \times 100 (\%)$$

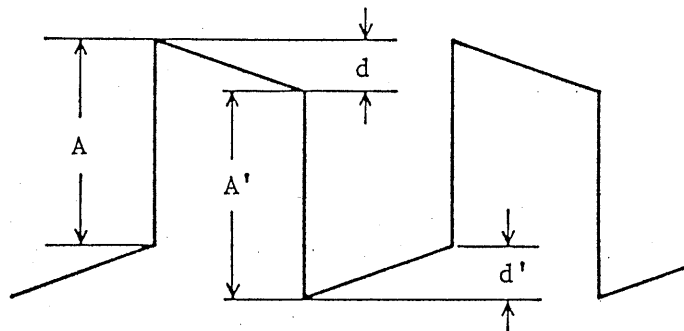

Figure 5-10

Note: If the AC-coupling mode is used for measurement of a low frequency pulse, sag is caused. For measurement of low frequency pulses, use always the DC-coupling mode.

843811

5.8 10:1 Probe Compensation

Each time the 10:1 probes are used with the instrument, probe compensation should be checked and adjusted if necessary.

A low capacitance screwdriver should be used. Use the following procedure for adjusting 10:1 probe compensation:

a. Connect the 10:1 probe to CH1 input (Figure 4-1 (21)).

b. Set the instrument controls as follows:

CH1 VOLTS/DIV	Figure 4-1 (23)	5 mV
A, B TIME/DIV	Figure 4-1 (39)	0.5 ms
CH1 input coupling	Figure 4-1 (20)	AC
Vertical MODE	Figure 4-1 (26)	CH1 depressed
COUPLING	Figure 4-1 (34)	AC
SOURCE	Figure 4-1 (35)	INT

c. Connect the 10:1 probe pickup to 200mV CAL(Vp-p) output (Figure 4-1 (43)).

d. Adjust CH1 POSITION (Figure 4-1 (24)) and HORIZ. POSITION (Figure 4-1 (44)) to display the top of at least complete positive pulse.

e. Adjust probe compensation (through hole in compensation box) for best flat top display. Refer to Figure 5-11.

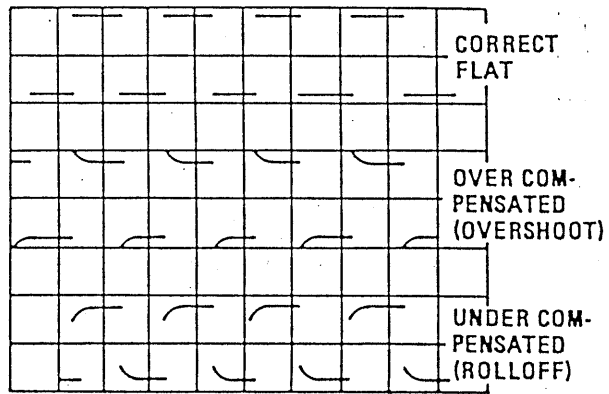
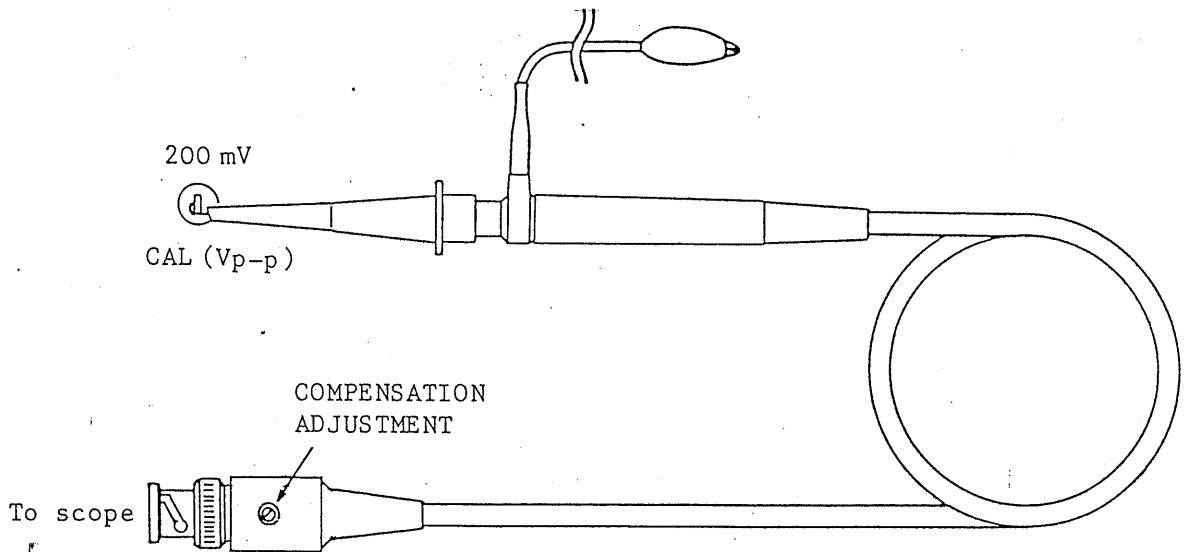
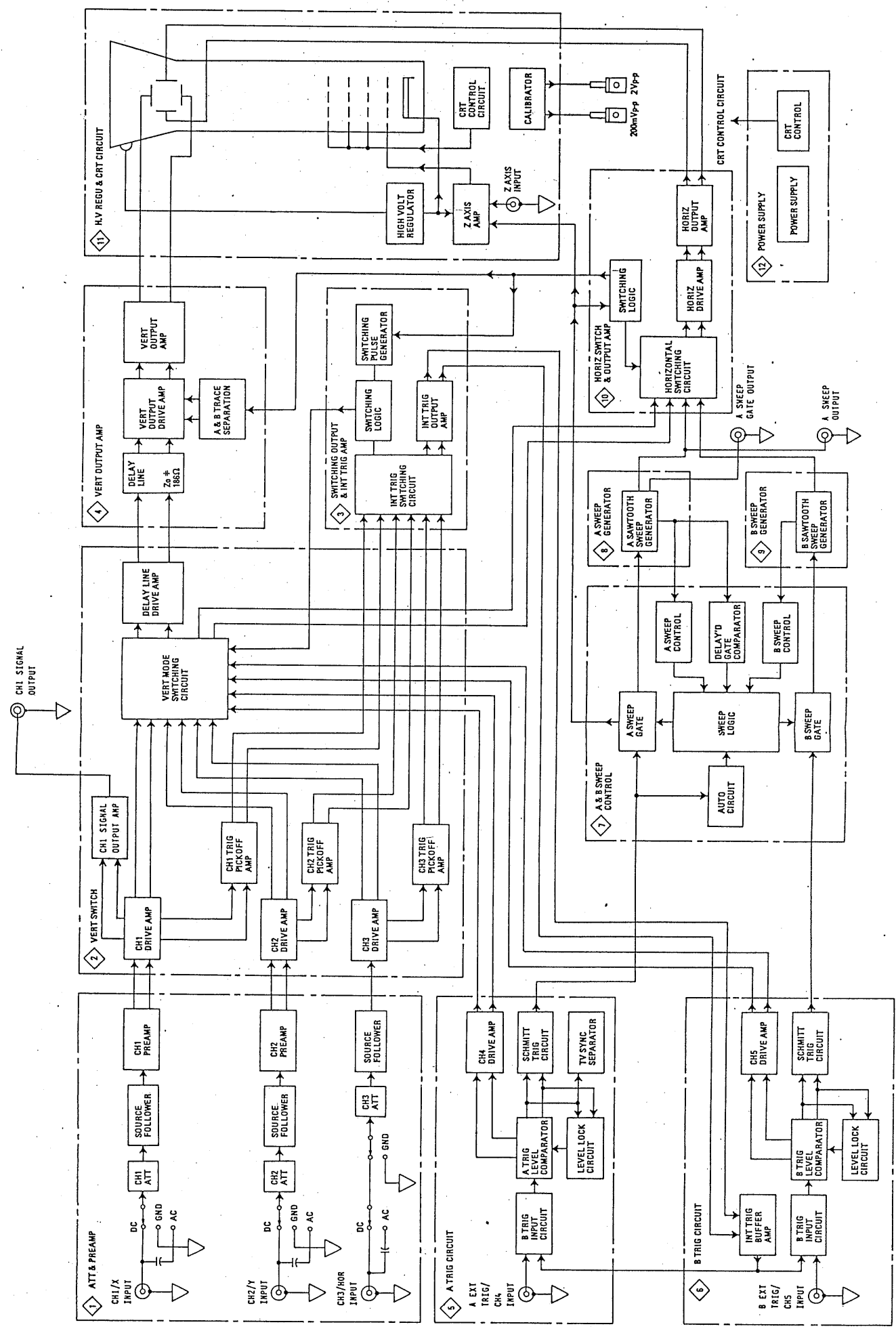

Figure 5-11. PROBE COMPENSATION

85. 3. 28 8438/3/A

843814



BLOCK DIAGRAM